

2019

PRODUCT CATALOG



DEĞERLİ®

www.degerlimakina.com







Adem DEĞERLİ
Genel Müdür
General Manager

ÖNSÖZ

INTRODUCTION

SEVGİLİ DOSTLARIMIZ ;

DEĞERLİ MAKİNA bilindiği üzere 1987 yılında KONYA'da başladığı HASSAS TUTUCU TAKIM imalatına bugüne kadar yapmış olduğu teknoloji yatırımları ile beraber, kalitesinden taviz vermeden sürekli ürün çeşidini artırma yolunda ilerlemiştir. Üretimini bir kısmını yurt dışına ihraç ederek de ülke ekonomisine ciddi girdiler sağlamıştır. Firmamız siz kıymetli dostlarımıza daha iyi hizmet verebilmek amacı ile makina parkını ve personel sayısını her geçen gün artırmaya devam etmektedir. Şirketimiz ürünlerinin kalitesini ve hizmet anlayışını siz değerli dostlarımız ile paylaşmak amacı ile bir çok fuara katılarak ismine yakışır bir tanıtım yapmış ve halen de yapmaya devam etmektedir. Ayrıca ürünlerimizin ve hizmetimizin kalitesini 2006 yılında büyük bir özveri ile çalışarak almaya hak kazandığı EN ISO 9001 kalite belgesi ile kanıtlamıştır.

Firmamız bundan böyle siz kıymetli dostlarımızında desteği ile daha da ileriye gidecek, aynı zamanda kalitesinden ve hizmetinden kesinlikle ödün vermeyecektir.

Dear All,

As it known, DEGERLİ MAKİNA began in 1987 in Konya PRECISION TOOL HOLDER manufacturing together with technology investments made by this time, along with continuous product range without compromising the quality of the way of improving progressed. By exporting a portion of is production abroad has contributed substantially to the national economy.

In order to better serve to our precious customers, our company always continues to increase its machinery and the number of stuff.

Our company has participated to various exhibitions and still continues to do well for sharing our sense of our quality and services with our dear friends, In addition, the quality of our products and our services is awarded in 2006 by working with a great sacrifice has been certified by ISO 9001 quality certificate.

Our company is now going even further with your precious support of but also will not compromise on quality and service, definitely.

KALİTE / QUALITY

KALİTE POLİTİKAMIZ

Müşterilerimize dünya standartlarında, yasal ve teknik mevzuata uygun kaliteli ürünler sunmak. Çalışanlarımızı ve tedarikçilerimizi büyüme ve gelişmemizde ortak bilip, teknolojideki yenilikleri firmamıza uyarlayarak sektörde lider firma olmak.

Personelimizin bilgi ve becerilerini artırma konusunda eğitime önem vermek.
Çevreye karşı saygılı olmak.

Sürekli iyileştirme anlayışı içinde, TEKNOLOJİ VE GÜVENİN BİRLEŞTİĞİ YER olan DEĞERLİ MAKİNA'YI her geçen gün yeni başarılarla taşımaktır.

QUALITY POLICY

Offering high quality products in worldwide standards suitable for legal and technical regulations.
Aiming to be the leader of the sector by applying technical renovations in our company and considering our staff and suppliers as partners in growing and improvement process.
Considering on the job training important to improve skills and cognition of our staff.
Being respectful to the environment.
In view of constantly improving, taking DEĞERLİ MAKİNA, where technology and confidence combined, to sustain new success in each day.



KALİTE / QUALITY

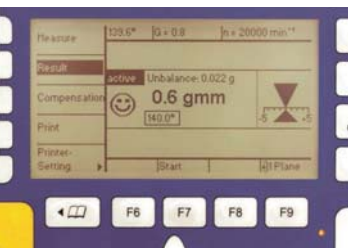

Ürünlerimizin kalitesinden taviz vermemek amacı ile imalat esnasında ve imalat sonrasında ürünler sürekli kontrol edilerek hataya sebebiyet vermemekteyiz. Bu kontrollerden en can alıcı olanları ise başta ISIL İŞLEM olmak üzere sonrasında yapılan SERTLİK ÖLÇME analizi, imalat esnasında yapılan YÜZEY PÜRÜZLÜLÜK hassasiyet ölçümü ve son olarak BALANS alma işlemidir. Bu işlemlerimizin tamamı raporlar halinde arşivlenerek muhafaza edilmektedir.

Ürünlerimizi müşterilerimiz tarafından daha anlaşılabilir olması için LAZER Markalama ile ürün bilgilerini ürünün üzerine yazmaktayız.

Böylelikle müşterilerimiz bir daha ürün ihtiyacı olduğunda tercihini buna göre yapması kolay olacaktır.

Sonuç olarak amacımız daha hassas ve daha kaliteli ürün imalatı yaparak müşterilerimizin memnuniyetini en üst seviyede tutmaktır.

In order to not to concession from the quality, the goods controlled during pre and post production process, so that we do not cause any error.

The most vital important controls are foremost THERMAL PROCESS, then HARDNESS MEASUREMENT analysis, sensitivity measurement of SURFACE ROUGHNESS during production and BALANCING process. All of these procedures are being documented and kept. The product information is written on the product by LASER MARKING for the customers to be well informed about the products. Thus, our customers will be able to choose the product easily next time. Consequently, our purpose is to manufacture more sensitive and quality goods and keep customer satisfaction at the highest level.





INDEX

PENSLER
COLLETS

A-01
A-26



**DIN 2080
ISO TUTUCULAR**
ISO TOOLHOLDERS

B-01
B-14



**JIS B 6339 (MAS 403 BT)
BT TUTUCULAR**
BT TOOLHOLDERS

C-01
C-30



**JIS B 6339 (MAS 403 BBT)
BBT TUTUCULAR**
BBT TOOLHOLDERS

D-01
D-17



**SİLİNDİRİK ŞAFTLI
TUTUCULAR**
*CYLINDRICAL SHAFT
TOOLHOLDERS*

E-01
E-14



**DIN 69871 AD
SK TUTUCULAR**
SK TOOLHOLDERS

F-01
F-29



MK TUTUCULAR
MK TOOLHOLDERS

G-01
G-09



DİĞER ÜRÜNLER
OTHER PRODUCTS

H-01
H-30

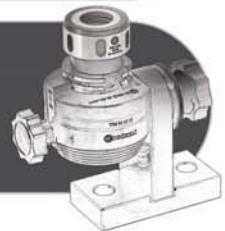



PENSLER
COLLETS

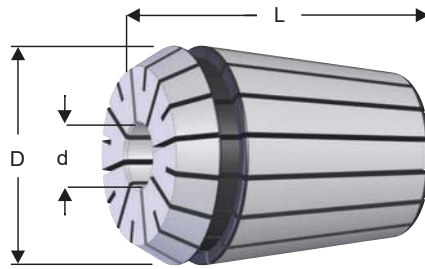

Sipariş Kodu Order Number	Ürün Adı Product Name	Kapasite Capacity (d)	D	L
100426.02	ER 16 - 426 PENS / ER 16 426 COLLET	2 mm	17	27,5
100426.03	ER 16 - 426 PENS / ER 16 426 COLLET	3 - 2 mm	17	27,5
100426.04	ER 16 - 426 PENS / ER 16 426 COLLET	4 - 3 mm	17	27,5
100426.05	ER 16 - 426 PENS / ER 16 426 COLLET	5 - 4 mm	17	27,5
100426.06	ER 16 - 426 PENS / ER 16 426 COLLET	6 - 5 mm	17	27,5
100426.07	ER 16 - 426 PENS / ER 16 426 COLLET	7 - 6 mm	17	27,5
100426.08	ER 16 - 426 PENS / ER 16 426 COLLET	8 - 7 mm	17	27,5
100426.09	ER 16 - 426 PENS / ER 16 426 COLLET	9 - 8 mm	17	27,5
100426.10	ER 16 - 426 PENS / ER 16 426 COLLET	10 - 9 mm	17	27,5

DIN 6499**ER 20 PENSLER****ER 20 COLLETS****DEĞERLİ®**

www.degerlimakina.com

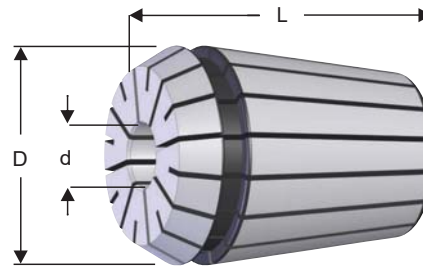

Sipariş Kodu Order Number	Ürün Adı Product Name	Kapasite Capacity (d)	D	L
100428.02	ER 20 - 428 PENS / ER 20 - 428 COLLET	2 mm	21	31,5
100428.03	ER 20 - 428 PENS / ER 20 - 428 COLLET	3 - 2 mm	21	31,5
100428.04	ER 20 - 428 PENS / ER 20 - 428 COLLET	4 - 3 mm	21	31,5
100428.05	ER 20 - 428 PENS / ER 20 - 428 COLLET	5 - 4 mm	21	31,5
100428.06	ER 20 - 428 PENS / ER 20 - 428 COLLET	6 - 5 mm	21	31,5
100428.07	ER 20 - 428 PENS / ER 20 - 428 COLLET	7 - 6 mm	21	31,5
100428.08	ER 20 - 428 PENS / ER 20 - 428 COLLET	8 - 7 mm	21	31,5
100428.09	ER 20 - 428 PENS / ER 20 - 428 COLLET	9 - 8 mm	21	31,5
100428.10	ER 20 - 428 PENS / ER 20 - 428 COLLET	10 - 9 mm	21	31,5
100428.11	ER 20 - 428 PENS / ER 20 - 428 COLLET	11 - 10 mm	21	31,5
100428.12	ER 20 - 428 PENS / ER 20 - 428 COLLET	12 - 11 mm	21	31,5
100428.13	ER 20 - 428 PENS / ER 20 - 428 COLLET	13 - 12 mm	21	31,5



DEĞERLİ
www.degerlimakina.com

DIN 6499

ER 25 PENSLER

ER 25 COLLETS

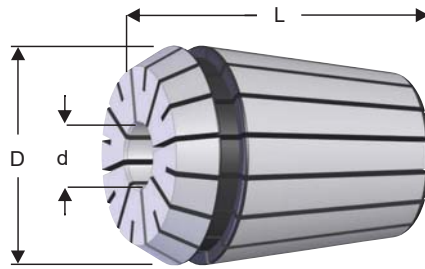

Sipariş Kodu Order Number	Ürün Adı Product Name	Kapasite Capacity (d)	D	L
100430.02	ER 25 - 430 PENS / ER 25 - 430 COLLET	2 mm	26	34
100430.03	ER 25 - 430 PENS / ER 25 - 430 COLLET	3 - 2 mm	26	34
100430.04	ER 25 - 430 PENS / ER 25 - 430 COLLET	4 - 3 mm	26	34
100430.05	ER 25 - 430 PENS / ER 25 - 430 COLLET	5 - 4 mm	26	34
100430.06	ER 25 - 430 PENS / ER 25 - 430 COLLET	6 - 5 mm	26	34
100430.07	ER 25 - 430 PENS / ER 25 - 430 COLLET	7 - 6 mm	26	34
100430.08	ER 25 - 430 PENS / ER 25 - 430 COLLET	8 - 7 mm	26	34
100430.09	ER 25 - 430 PENS / ER 25 - 430 COLLET	9 - 8 mm	26	34
100430.10	ER 25 - 430 PENS / ER 25 - 430 COLLET	10 - 9 mm	26	34
100430.11	ER 25 - 430 PENS / ER 25 - 430 COLLET	11 - 10 mm	26	34
100430.12	ER 25 - 430 PENS / ER 25 - 430 COLLET	12 - 11 mm	26	34
100430.13	ER 25 - 430 PENS / ER 25 - 430 COLLET	13 - 12 mm	26	34
100430.14	ER 25 - 430 PENS / ER 25 - 430 COLLET	14 - 13 mm	26	34
100430.15	ER 25 - 430 PENS / ER 25 - 430 COLLET	15 - 14 mm	26	34
100430.16	ER 25 - 430 PENS / ER 25 - 430 COLLET	16 - 15 mm	26	34

DIN 6499**ER 32 PENSLER****ER 32 COLLETS****DEĞERLİ**
www.degerlimakina.com

SAYFA/PAGE: H-05



SAYFA/PAGE: H-15



SAYFA/PAGE: A-24/25



SAYFA/PAGE: C-29/D-16



SAYFA/PAGE: F-28



SAYFA/PAGE: B-14



SAYFA/PAGE: E-14



58-60 HRC

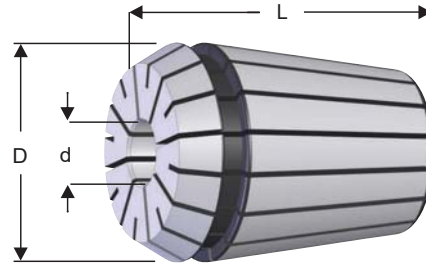

Sipariş Kodu Order Number	Ürün Adı Product Name	Kapasite Capacity (d)	D	L
100470.02	ER 32 - 470 PENS / ER 32 - 470 COLLET	2 mm	33	40
100470.03	ER 32 - 470 PENS / ER 32 - 470 COLLET	3 - 2 mm	33	40
100470.04	ER 32 - 470 PENS / ER 32 - 470 COLLET	4 - 3 mm	33	40
100470.05	ER 32 - 470 PENS / ER 32 - 470 COLLET	5 - 4 mm	33	40
100470.06	ER 32 - 470 PENS / ER 32 - 470 COLLET	6 - 5 mm	33	40
100470.07	ER 32 - 470 PENS / ER 32 - 470 COLLET	7 - 6 mm	33	40
100470.08	ER 32 - 470 PENS / ER 32 - 470 COLLET	8 - 7 mm	33	40
100470.09	ER 32 - 470 PENS / ER 32 - 470 COLLET	9 - 8 mm	33	40
100470.10	ER 32 - 470 PENS / ER 32 - 470 COLLET	10 - 9 mm	33	40
100470.11	ER 32 - 470 PENS / ER 32 - 470 COLLET	11 - 10 mm	33	40
100470.12	ER 32 - 470 PENS / ER 32 - 470 COLLET	12 - 11 mm	33	40
100470.13	ER 32 - 470 PENS / ER 32 - 470 COLLET	13 - 12 mm	33	40
100470.14	ER 32 - 470 PENS / ER 32 - 470 COLLET	14 - 13 mm	33	40
100470.15	ER 32 - 470 PENS / ER 32 - 470 COLLET	15 - 14 mm	33	40
100470.16	ER 32 - 470 PENS / ER 32 - 470 COLLET	16 - 15 mm	33	40
100470.17	ER 32 - 470 PENS / ER 32 - 470 COLLET	17 - 16 mm	33	40
100470.18	ER 32 - 470 PENS / ER 32 - 470 COLLET	18 - 17 mm	33	40
100470.19	ER 32 - 470 PENS / ER 32 - 470 COLLET	19 - 18 mm	33	40
100470.20	ER 32 - 470 PENS / ER 32 - 470 COLLET	20 - 19 mm	33	40



DEĞERLİ
www.degerlimakina.com

DIN 6499

ER 40 PENSLER

ER 40 COLLETS

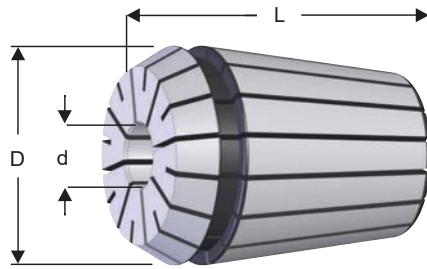

Sipariş Kodu Order Number	Ürün Adı Product Name	Kapasite Capacity (d)	D	L
100472.02	ER 40 - 472 PENS / ER 40 - 472 COLLET	2 mm	41	46
100472.03	ER 40 - 472 PENS / ER 40 - 472 COLLET	3 - 2 mm	41	46
100472.04	ER 40 - 472 PENS / ER 40 - 472 COLLET	4 - 3 mm	41	46
100472.05	ER 40 - 472 PENS / ER 40 - 472 COLLET	5 - 4 mm	41	46
100472.06	ER 40 - 472 PENS / ER 40 - 472 COLLET	6 - 5 mm	41	46
100472.07	ER 40 - 472 PENS / ER 40 - 472 COLLET	7 - 6 mm	41	46
100472.08	ER 40 - 472 PENS / ER 40 - 472 COLLET	8 - 7 mm	41	46
100472.09	ER 40 - 472 PENS / ER 40 - 472 COLLET	9 - 8 mm	41	46
100472.10	ER 40 - 472 PENS / ER 40 - 472 COLLET	10 - 9 mm	41	46
100472.11	ER 40 - 472 PENS / ER 40 - 472 COLLET	11 - 10 mm	41	46
100472.12	ER 40 - 472 PENS / ER 40 - 472 COLLET	12 - 11 mm	41	46
100472.13	ER 40 - 472 PENS / ER 40 - 472 COLLET	13 - 12 mm	41	46
100472.14	ER 40 - 472 PENS / ER 40 - 472 COLLET	14 - 13 mm	41	46
100472.15	ER 40 - 472 PENS / ER 40 - 472 COLLET	15 - 14 mm	41	46
100472.16	ER 40 - 472 PENS / ER 40 - 472 COLLET	16 - 15 mm	41	46
100472.17	ER 40 - 472 PENS / ER 40 - 472 COLLET	17 - 16 mm	41	46
100472.18	ER 40 - 472 PENS / ER 40 - 472 COLLET	18 - 17 mm	41	46
100472.19	ER 40 - 472 PENS / ER 40 - 472 COLLET	19 - 18 mm	41	46
100472.20	ER 40 - 472 PENS / ER 40 - 472 COLLET	20 - 19 mm	41	46
100472.21	ER 40 - 472 PENS / ER 40 - 472 COLLET	21 - 20 mm	41	46
100472.22	ER 40 - 472 PENS / ER 40 - 472 COLLET	22 - 21 mm	41	46
100472.23	ER 40 - 472 PENS / ER 40 - 472 COLLET	23 - 22 mm	41	46
100472.24	ER 40 - 472 PENS / ER 40 - 472 COLLET	24 - 23 mm	41	46
100472.25	ER 40 - 472 PENS / ER 40 - 472 COLLET	25 - 24 mm	41	46
100472.26	ER 40 - 472 PENS / ER 40 - 472 COLLET	26 - 25 mm	41	46

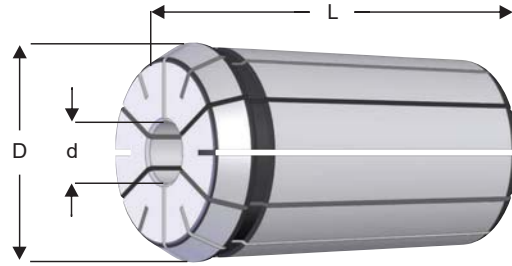

Sipariş Kodu Order Number	Ürün Adı Product Name	Kapasite Capacity (d)	D	L
100407.03	407 PENS / 407 COLLET	3 - 2,5 mm	19,8	34
100407.04	407 PENS / 407 COLLET	4 - 3,5 mm	19,8	34
100407.05	407 PENS / 407 COLLET	5 - 4,5 mm	19,8	34
100407.06	407 PENS / 407 COLLET	6 - 5,5 mm	19,8	34
100407.07	407 PENS / 407 COLLET	7 - 6,5 mm	19,8	34
100407.08	407 PENS / 407 COLLET	8 - 7,5 mm	19,8	34
100407.09	407 PENS / 407 COLLET	9 - 8,5 mm	19,8	34
100407.10	407 PENS / 407 COLLET	10 - 9,5 mm	19,8	34
100407.11	407 PENS / 407 COLLET	11 - 10,5 mm	19,8	34
100407.12	407 PENS / 407 COLLET	12 - 11,5 mm	19,8	34



DEĞERLİ
www.degerlimakina.com

DIN 6388

415 PENSLER

415 COLLETS

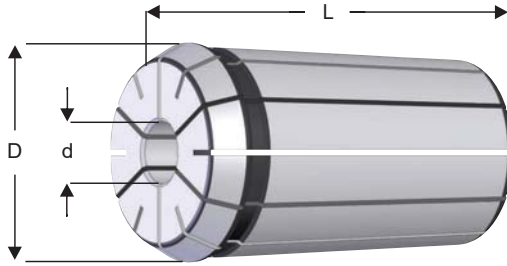

Sipariş Kodu Order Number	Ürün Adı Product Name	Kapasite Capacity (d)	D	L
100415.03	415 PENS / 415 COLLET	3 - 2,5 mm	25,5	40
100415.04	415 PENS / 415 COLLET	4 - 3,5 mm	25,5	40
100415.05	415 PENS / 415 COLLET	5 - 4,5 mm	25,5	40
100415.06	415 PENS / 415 COLLET	6 - 5,5 mm	25,5	40
100415.07	415 PENS / 415 COLLET	7 - 6,5 mm	25,5	40
100415.08	415 PENS / 415 COLLET	8 - 7,5 mm	25,5	40
100415.09	415 PENS / 415 COLLET	9 - 8,5 mm	25,5	40
100415.10	415 PENS / 415 COLLET	10 - 9,5 mm	25,5	40
100415.11	415 PENS / 415 COLLET	11 - 10,5 mm	25,5	40
100415.12	415 PENS / 415 COLLET	12 - 11,5 mm	25,5	40
100415.13	415 PENS / 415 COLLET	13 - 12,5 mm	25,5	40
100415.14	415 PENS / 415 COLLET	14 - 13,5 mm	25,5	40
100415.15	415 PENS / 415 COLLET	15 - 14,5 mm	25,5	40
100415.16	415 PENS / 415 COLLET	16 - 15,5 mm	25,5	40

DIN 6388**440 PENSLER****440 COLLETS****DEĞERLİ®**

www.degerlimakina.com

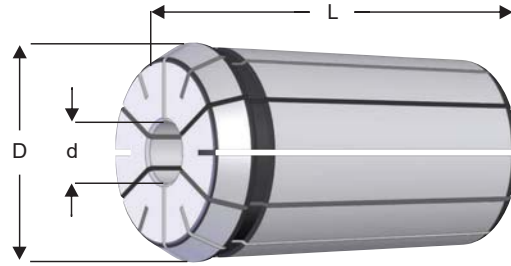

Sipariş Kodu Order Number	Ürün Adı Product Name	Kapasite Capacity (d)	D	L
100440.03	440 PENS / 440 COLLET	3 - 2,5 mm	29,8	45
100440.04	440 PENS / 440 COLLET	4 - 3,5 mm	29,8	45
100440.05	440 PENS / 440 COLLET	5 - 4,5 mm	29,8	45
100440.06	440 PENS / 440 COLLET	6 - 5,5 mm	29,8	45
100440.07	440 PENS / 440 COLLET	7 - 6,5 mm	29,8	45
100440.08	440 PENS / 440 COLLET	8 - 7,5 mm	29,8	45
100440.09	440 PENS / 440 COLLET	9 - 8,5 mm	29,8	45
100440.10	440 PENS / 440 COLLET	10 - 9,5 mm	29,8	45
100440.11	440 PENS / 440 COLLET	11 - 10,5 mm	29,8	45
100440.12	440 PENS / 440 COLLET	12 - 11,5 mm	29,8	45
100440.13	440 PENS / 440 COLLET	13 - 12,5 mm	29,8	45
100440.14	440 PENS / 440 COLLET	14 - 13,5 mm	29,8	45
100440.15	440 PENS / 440 COLLET	15 - 14,5 mm	29,8	45
100440.16	440 PENS / 440 COLLET	16 - 15,5 mm	29,8	45
100440.17	440 PENS / 440 COLLET	17 - 16,5 mm	29,8	45
100440.18	440 PENS / 440 COLLET	18 - 17,5 mm	29,8	45
100440.19	440 PENS / 440 COLLET	19 - 18,5 mm	29,8	45
100440.20	440 PENS / 440 COLLET	20 - 19,5 mm	29,8	45



DEĞERLİ
www.degerlimakina.com

DIN 6388

462 PENSLER

462 COLLETS

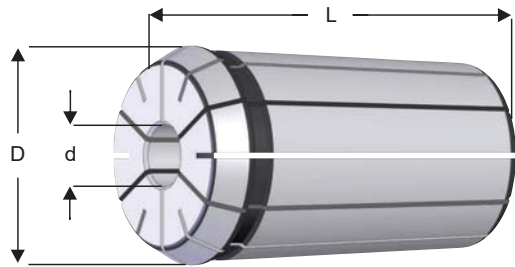

Sipariş Kodu Order Number	Ürün Adı Product Name	Kapasite Capacity (d)	D	L
100462.02	462 PENS / 462 COLLET	2 mm	35,05	52
100462.03	462 PENS / 462 COLLET	3 - 2,5 mm	35,05	52
100462.04	462 PENS / 462 COLLET	4 - 3,5 mm	35,05	52
100462.05	462 PENS / 462 COLLET	5 - 4,5 mm	35,05	52
100462.06	462 PENS / 462 COLLET	6 - 5,5 mm	35,05	52
100462.07	462 PENS / 462 COLLET	7 - 6,5 mm	35,05	52
100462.08	462 PENS / 462 COLLET	8 - 7,5 mm	35,05	52
100462.09	462 PENS / 462 COLLET	9 - 8,5 mm	35,05	52
100462.10	462 PENS / 462 COLLET	10 - 9,5 mm	35,05	52
100462.11	462 PENS / 462 COLLET	11 - 10,5 mm	35,05	52
100462.12	462 PENS / 462 COLLET	12 - 11,5 mm	35,05	52
100462.13	462 PENS / 462 COLLET	13 - 12,5 mm	35,05	52
100462.14	462 PENS / 462 COLLET	14 - 13,5 mm	35,05	52
100462.15	462 PENS / 462 COLLET	15 - 14,5 mm	35,05	52
100462.16	462 PENS / 462 COLLET	16 - 15,5 mm	35,05	52
100462.17	462 PENS / 462 COLLET	17 - 16,5 mm	35,05	52
100462.18	462 PENS / 462 COLLET	18 - 17,5 mm	35,05	52
100462.19	462 PENS / 462 COLLET	19 - 18,5 mm	35,05	52
100462.20	462 PENS / 462 COLLET	20 - 19,5 mm	35,05	52
100462.21	462 PENS / 462 COLLET	21 - 20,5 mm	35,05	52
100462.22	462 PENS / 462 COLLET	22 - 21,5 mm	35,05	52
100462.23	462 PENS / 462 COLLET	23 - 22,5 mm	35,05	52
100462.24	462 PENS / 462 COLLET	24 - 23,5 mm	35,05	52
100462.25	462 PENS / 462 COLLET	25 - 24,5 mm	35,05	52

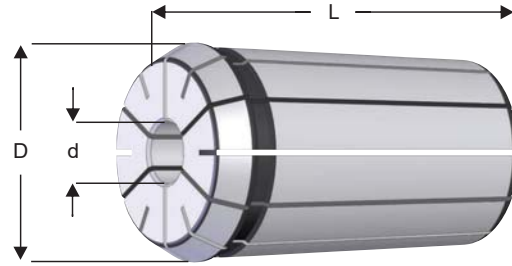
DIN 6388**467 PENSLER****467 COLLETS****DEĞERLİ**
www.degerlimakina.com

Sipariş Kodu Order Number	Kapasite Capacity (d)	D	L
100467.03	3 - 2,5 mm	43,7	60
100467.04	4 - 3,5 mm	43,7	60
100467.05	5 - 4,5 mm	43,7	60
100467.06	6 - 5,5 mm	43,7	60
100467.07	7 - 6,5 mm	43,7	60
100467.08	8 - 7,5 mm	43,7	60
100467.09	9 - 8,5 mm	43,7	60
100467.10	10 - 9,5 mm	43,7	60
100467.11	11 - 10,5 mm	43,7	60
100467.12	12 - 11,5 mm	43,7	60
100467.13	13 - 12,5 mm	43,7	60
100467.14	14 - 13,5 mm	43,7	60
100467.15	15 - 14,5 mm	43,7	60
100467.16	16 - 15,5 mm	43,7	60
100467.17	17 - 16,5 mm	43,7	60

Sipariş Kodu Order Number	Kapasite Capacity (d)	D	L
100467.18	18 - 17,5 mm	43,7	60
100467.19	19 - 18,5 mm	43,7	60
100467.20	20 - 19,5 mm	43,7	60
100467.21	21 - 20,5 mm	43,7	60
100467.22	22 - 21,5 mm	43,7	60
100467.23	23 - 22,5 mm	43,7	60
100467.24	24 - 23,5 mm	43,7	60
100467.25	25 - 24,5 mm	43,7	60
100467.26	26 - 25,5 mm	43,7	60
100467.27	27 - 26,5 mm	43,7	60
100467.28	28 - 27,5 mm	43,7	60
100467.29	29 - 28,5 mm	43,7	60
100467.30	30 - 29,5 mm	43,7	60
100467.31	31 - 30,5 mm	43,7	60
100467.32	32 - 31,5 mm	43,7	60

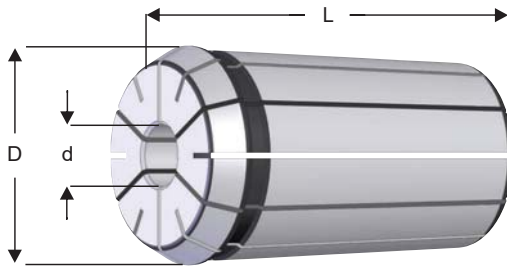

Sipariş Kodu Order Number	Kapasite Capacity (d)	D	L
100468.04	4 - 3,5 mm	52,2	68
100468.05	5 - 4,5 mm	52,2	68
100468.06	6 - 5,5 mm	52,2	68
100468.07	7 - 6,5 mm	52,2	68
100468.08	8 - 7,5 mm	52,2	68
100468.09	9 - 8,5 mm	52,2	68
100468.10	10 - 9,5 mm	52,2	68
100468.11	11 - 10,5 mm	52,2	68
100468.12	12 - 11,5 mm	52,2	68
100468.13	13 - 12,5 mm	52,2	68
100468.14	14 - 13,5 mm	52,2	68
100468.15	15 - 14,5 mm	52,2	68
100468.16	16 - 15,5 mm	52,2	68
100468.17	17 - 16,5 mm	52,2	68
100468.18	18 - 17,5 mm	52,2	68
100468.19	19 - 18,5 mm	52,2	68
100468.20	20 - 19,5 mm	52,2	68
100468.21	21 - 20,5 mm	52,2	68
100468.22	22 - 21,5 mm	52,2	68

Sipariş Kodu Order Number	Kapasite Capacity (d)	D	L
100468.23	23 - 22,5 mm	52,2	68
100468.24	24 - 23,5 mm	52,2	68
100468.25	25 - 24,5 mm	52,2	68
100468.26	26 - 25,5 mm	52,2	68
100468.27	27 - 26,5 mm	52,2	68
100468.28	28 - 27,5 mm	52,2	68
100468.29	29 - 28,5 mm	52,2	68
100468.30	30 - 29,5 mm	52,2	68
100468.31	31 - 30,5 mm	52,2	68
100468.32	32 - 31,5 mm	52,2	68
100468.33	33 - 32,5 mm	52,2	68
100468.34	34 - 33,5 mm	52,2	68
100468.35	35 - 34,5 mm	52,2	68
100468.36	36 - 35,5 mm	52,2	68
100468.37	37 - 36,5 mm	52,2	68
100468.38	38 - 37,5 mm	52,2	68
100468.39	39 - 38,5 mm	52,2	68
100468.40	40 - 39,5 mm	52,2	68

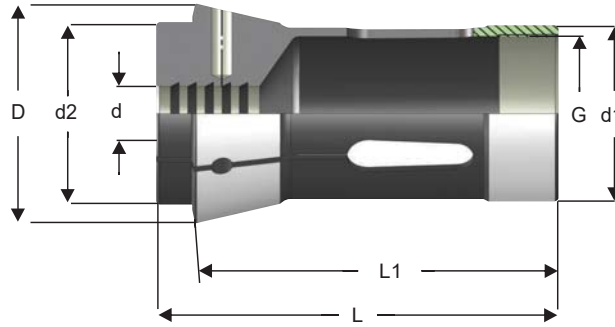
DIN 6343**140/148/161/163 PENSLER****COLLETS****DEĞERLİ®**
www.degerlimakina.com

Sipariş Kodu Order Number	Ürün Adı Product Name	Kapasite Capacity (d)	d1	d2	D	L1	L	G
110016.XX	140 YUVARLAK PENS / CYLINDER COLLET	3-17 mm	22	21	30	49	55	M18x1
111016.XX	140 ALTİKÖŞE PENS / HEXAGON COLLET	6-13 mm	22	21	30	49	55	M18x1
110020.XX	148 YUVARLAK PENS / CYLINDER COLLET	3-22 mm	28	28	38	63	70	M23x1
111020.XX	148 ALTİKÖŞE PENS / HEXAGON COLLET	6-18 mm	28	28	38	63	70	M23x1
110025.XX	161 YUVARLAK PENS / CYLINDER COLLET	3-27 mm	32	34	45	67	75	M28x1
111025.XX	161 ALTİKÖŞE PENS / HEXAGON COLLET	6-22 mm	32	34	45	67	75	M28x1
110030.XX	163 YUVARLAK PENS / CYLINDER COLLET	4-32 mm	35	38	48	72	80	M31x1
111030.XX	163 ALTİKÖŞE PENS / HEXAGON COLLET	6-26 mm	35	38	48	72	80	M31x1

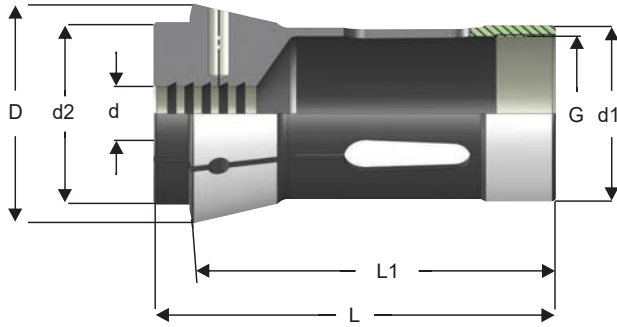

Sipariş Kodu Order Number	d	d1	d2	D	L1	L	G
110042.03	3	48	50	60	85	94	M43x1
110042.04	4	48	50	60	85	94	M43x1
110042.05	5	48	50	60	85	94	M43x1
110042.06	6	48	50	60	85	94	M43x1
110042.07	7	48	50	60	85	94	M43x1
110042.08	8	48	50	60	85	94	M43x1
110042.09	9	48	50	60	85	94	M43x1
110042.10	10	48	50	60	85	94	M43x1
110042.11	11	48	50	60	85	94	M43x1
110042.12	12	48	50	60	85	94	M43x1
110042.13	13	48	50	60	85	94	M43x1
110042.14	14	48	50	60	85	94	M43x1
110042.15	15	48	50	60	85	94	M43x1
110042.16	16	48	50	60	85	94	M43x1
110042.17	17	48	50	60	85	94	M43x1
110042.18	18	48	50	60	85	94	M43x1
110042.19	19	48	50	60	85	94	M43x1
110042.20	20	48	50	60	85	94	M43x1
110042.21	21	48	50	60	85	94	M43x1
110042.22	22	48	50	60	85	94	M43x1

Sipariş Kodu Order Number	d	d1	d2	D	L1	L	G
110042.23	23	48	50	60	85	94	M43x1
110042.24	24	48	50	60	85	94	M43x1
110042.25	25	48	50	60	85	94	M43x1
110042.26	26	48	50	60	85	94	M43x1
110042.27	27	48	50	60	85	94	M43x1
110042.28	28	48	50	60	85	94	M43x1
110042.29	29	48	50	60	85	94	M43x1
110042.30	30	48	50	60	85	94	M43x1
110042.31	31	48	50	60	85	94	M43x1
110042.32	32	48	50	60	85	94	M43x1
110042.33	33	48	50	60	85	94	M43x1
110042.34	34	48	50	60	85	94	M43x1
110042.35	35	48	50	60	85	94	M43x1
110042.36	36	48	50	60	85	94	M43x1
110042.37	37	48	50	60	85	94	M43x1
110042.38	38	48	50	60	85	94	M43x1
110042.39	39	48	50	60	85	94	M43x1
110042.40	40	48	50	60	85	94	M43x1
110042.41	41	48	50	60	85	94	M43x1
110042.42	42	48	50	60	85	94	M43x1

DIN 6343**173 ALTİKÖŞE PENSLER****173 HEXAGON COLLETS****DEĞERLİ®**

www.degerlimakina.com

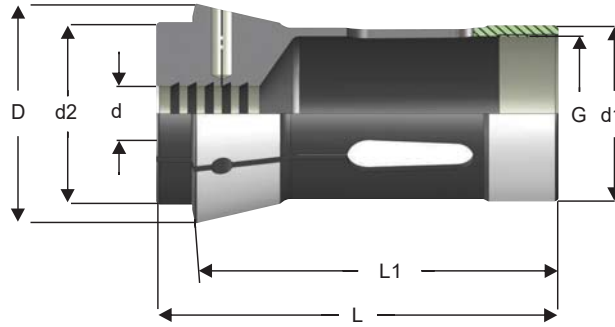
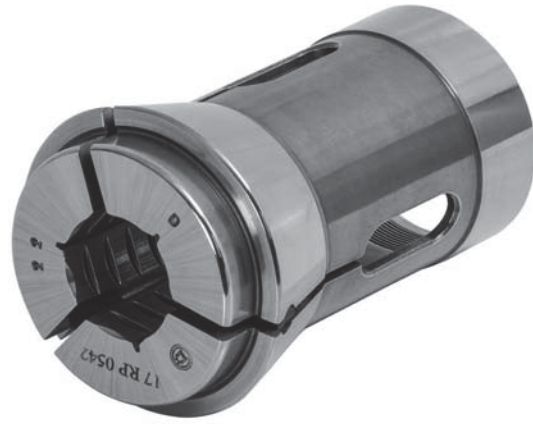

Sipariş Kodu Order Number	d	d1	d2	D	L1	L	G
111042.06	6	48	50	60	85	94	M43x1
111042.07	7	48	50	60	85	94	M43x1
111042.08	8	48	50	60	85	94	M43x1
111042.09	9	48	50	60	85	94	M43x1
111042.10	10	48	50	60	85	94	M43x1
111042.11	11	48	50	60	85	94	M43x1
111042.12	12	48	50	60	85	94	M43x1
111042.13	13	48	50	60	85	94	M43x1
111042.14	14	48	50	60	85	94	M43x1
111042.15	15	48	50	60	85	94	M43x1
111042.16	16	48	50	60	85	94	M43x1
111042.17	17	48	50	60	85	94	M43x1
111042.18	18	48	50	60	85	94	M43x1
111042.19	19	48	50	60	85	94	M43x1
111042.20	20	48	50	60	85	94	M43x1
111042.21	21	48	50	60	85	94	M43x1

Sipariş Kodu Order Number	d	d1	d2	D	L1	L	G
111042.22	22	48	50	60	85	94	M43x1
111042.23	23	48	50	60	85	94	M43x1
111042.24	24	48	50	60	85	94	M43x1
111042.25	25	48	50	60	85	94	M43x1
111042.26	26	48	50	60	85	94	M43x1
111042.27	27	48	50	60	85	94	M43x1
111042.28	28	48	50	60	85	94	M43x1
111042.29	29	48	50	60	85	94	M43x1
111042.30	30	48	50	60	85	94	M43x1
111042.31	31	48	50	60	85	94	M43x1
111042.32	32	48	50	60	85	94	M43x1
111042.33	33	48	50	60	85	94	M43x1
111042.34	34	48	50	60	85	94	M43x1
111042.35	35	48	50	60	85	94	M43x1
111042.36	36	48	50	60	85	94	M43x1
111042.37	37	48	50	60	85	94	M43x1

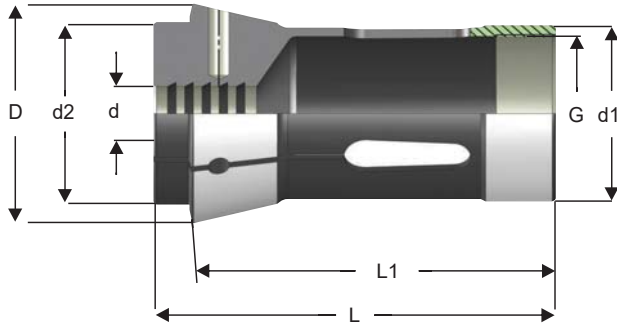

Sipariş Kodu Order Number	d	d1	d2	D	L1	L	G
110060.06	6	66	73	84	101	110	M61x1
110060.07	7	66	73	84	101	110	M61x1
110060.08	8	66	73	84	101	110	M61x1
110060.09	9	66	73	84	101	110	M61x1
110060.10	10	66	73	84	101	110	M61x1
110060.11	11	66	73	84	101	110	M61x1
110060.12	12	66	73	84	101	110	M61x1
110060.13	13	66	73	84	101	110	M61x1
110060.14	14	66	73	84	101	110	M61x1
110060.15	15	66	73	84	101	110	M61x1
110060.16	16	66	73	84	101	110	M61x1
110060.17	17	66	73	84	101	110	M61x1
110060.18	18	66	73	84	101	110	M61x1
110060.19	19	66	73	84	101	110	M61x1
110060.20	20	66	73	84	101	110	M61x1
110060.21	21	66	73	84	101	110	M61x1
110060.22	22	66	73	84	101	110	M61x1
110060.23	23	66	73	84	101	110	M61x1
110060.24	24	66	73	84	101	110	M61x1
110060.25	25	66	73	84	101	110	M61x1
110060.26	26	66	73	84	101	110	M61x1
110060.27	27	66	73	84	101	110	M61x1
110060.28	28	66	73	84	101	110	M61x1
110060.29	29	66	73	84	101	110	M61x1
110060.30	30	66	73	84	101	110	M61x1
110060.31	31	66	73	84	101	110	M61x1
110060.32	32	66	73	84	101	110	M61x1
110060.33	33	66	73	84	101	110	M61x1

Sipariş Kodu Order Number	d	d1	d2	D	L1	L	G
110060.34	34	66	73	84	101	110	M61x1
110060.35	35	66	73	84	101	110	M61x1
110060.36	36	66	73	84	101	110	M61x1
110060.37	37	66	73	84	101	110	M61x1
110060.38	38	66	73	84	101	110	M61x1
110060.39	39	66	73	84	101	110	M61x1
110060.40	40	66	73	84	101	110	M61x1
110060.41	41	66	73	84	101	110	M61x1
110060.42	42	66	73	84	101	110	M61x1
110060.43	43	66	73	84	101	110	M61x1
110060.44	44	66	73	84	101	110	M61x1
110060.45	45	66	73	84	101	110	M61x1
110060.46	46	66	73	84	101	110	M61x1
110060.47	47	66	73	84	101	110	M61x1
110060.48	48	66	73	84	101	110	M61x1
110060.49	49	66	73	84	101	110	M61x1
110060.50	50	66	73	84	101	110	M61x1
110060.51	51	66	73	84	101	110	M61x1
110060.52	52	66	73	84	101	110	M61x1
110060.53	53	66	73	84	101	110	M61x1
110060.54	54	66	73	84	101	110	M61x1
110060.55	55	66	73	84	101	110	M61x1
110060.56	56	66	73	84	101	110	M61x1
110060.57	57	66	73	84	101	110	M61x1
110060.58	58	66	73	84	101	110	M61x1
110060.59	59	66	73	84	101	110	M61x1
110060.60	60	66	73	84	101	110	M61x1

DIN 6343**185 ALTİKÖŞE PENSLER****185 HEXAGON COLLETS****DEĞERLİ®**

www.degerlimakina.com

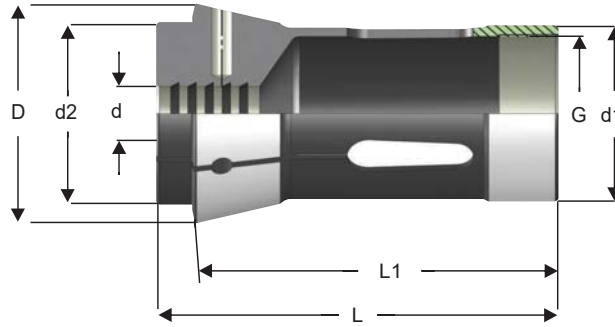

Sipariş Kodu Order Number	d	d1	d2	D	L1	L	G
111060.08	8	66	73	84	101	110	M61x1
111060.09	9	66	73	84	101	110	M61x1
111060.10	10	66	73	84	101	110	M61x1
111060.11	11	66	73	84	101	110	M61x1
111060.12	12	66	73	84	101	110	M61x1
111060.13	13	66	73	84	101	110	M61x1
111060.14	14	66	73	84	101	110	M61x1
111060.15	15	66	73	84	101	110	M61x1
111060.16	16	66	73	84	101	110	M61x1
111060.17	17	66	73	84	101	110	M61x1
111060.18	18	66	73	84	101	110	M61x1
111060.19	19	66	73	84	101	110	M61x1
111060.20	20	66	73	84	101	110	M61x1
111060.21	21	66	73	84	101	110	M61x1
111060.22	22	66	73	84	101	110	M61x1
111060.23	23	66	73	84	101	110	M61x1
111060.24	24	66	73	84	101	110	M61x1
111060.25	25	66	73	84	101	110	M61x1
111060.26	26	66	73	84	101	110	M61x1
111060.27	27	66	73	84	101	110	M61x1
111060.28	28	66	73	84	101	110	M61x1
111060.29	29	66	73	84	101	110	M61x1
111060.30	30	66	73	84	101	110	M61x1

Sipariş Kodu Order Number	d	d1	d2	D	L1	L	G
111060.31	31	66	73	84	101	110	M61x1
111060.32	32	66	73	84	101	110	M61x1
111060.33	33	66	73	84	101	110	M61x1
111060.34	34	66	73	84	101	110	M61x1
111060.35	35	66	73	84	101	110	M61x1
111060.36	36	66	73	84	101	110	M61x1
111060.37	37	66	73	84	101	110	M61x1
111060.38	38	66	73	84	101	110	M61x1
111060.39	39	66	73	84	101	110	M61x1
111060.40	40	66	73	84	101	110	M61x1
111060.41	41	66	73	84	101	110	M61x1
111060.42	42	66	73	84	101	110	M61x1
111060.43	43	66	73	84	101	110	M61x1
111060.44	44	66	73	84	101	110	M61x1
111060.45	45	66	73	84	101	110	M61x1
111060.46	46	66	73	84	101	110	M61x1
111060.47	47	66	73	84	101	110	M61x1
111060.48	48	66	73	84	101	110	M61x1
111060.49	49	66	73	84	101	110	M61x1
111060.50	50	66	73	84	101	110	M61x1
111060.51	51	66	73	84	101	110	M61x1
111060.52	52	66	73	84	101	110	M61x1

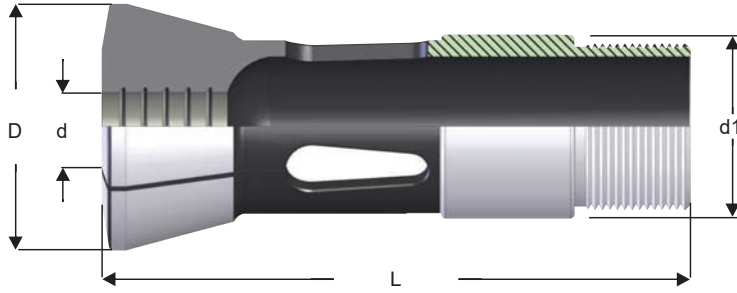

Sipariş Kodu Order Number	d	d1	D	L
140000.03	3	43	57,5	137
140000.04	4	43	57,5	137
140000.05	5	43	57,5	137
140000.06	6	43	57,5	137
140000.07	7	43	57,5	137
140000.08	8	43	57,5	137
140000.09	9	43	57,5	137
140000.10	10	43	57,5	137
140000.11	11	43	57,5	137
140000.12	12	43	57,5	137
140000.13	13	43	57,5	137
140000.14	14	43	57,5	137
140000.15	15	43	57,5	137
140000.16	16	43	57,5	137
140000.17	17	43	57,5	137

Sipariş Kodu Order Number	d	d1	D	L
140000.18	18	43	57,5	137
140000.19	19	43	57,5	137
140000.20	20	43	57,5	137
140000.21	21	43	57,5	137
140000.22	22	43	57,5	137
140000.23	23	43	57,5	137
140000.24	24	43	57,5	137
140000.25	25	43	57,5	137
140000.26	26	43	57,5	137
140000.27	27	43	57,5	137
140000.28	28	43	57,5	137
140000.29	29	43	57,5	137
140000.30	30	43	57,5	137
140000.31	31	43	57,5	137
140000.32	32	43	57,5	137

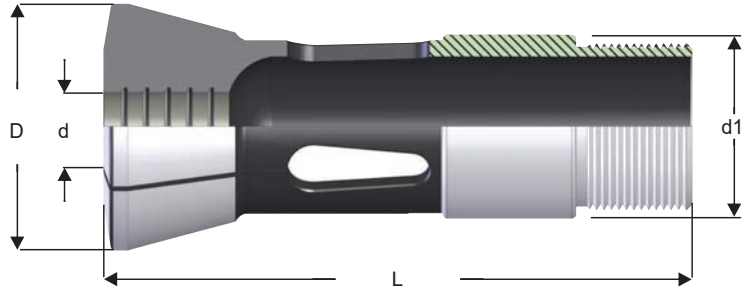

Sipariş Kodu Order Number	d	d1	D	L
141000.06	6	43	57,5	137
141000.07	7	43	57,5	137
141000.08	8	43	57,5	137
141000.09	9	43	57,5	137
141000.10	10	43	57,5	137
141000.11	11	43	57,5	137
141000.12	12	43	57,5	137
141000.13	13	43	57,5	137
141000.14	14	43	57,5	137
141000.15	15	43	57,5	137
141000.16	16	43	57,5	137

Sipariş Kodu Order Number	d	d1	D	L
141000.17	17	43	57,5	137
141000.18	18	43	57,5	137
141000.19	19	43	57,5	137
141000.20	20	43	57,5	137
141000.21	21	43	57,5	137
141000.22	22	43	57,5	137
141000.23	23	43	57,5	137
141000.24	24	43	57,5	137
141000.25	25	43	57,5	137
141000.26	26	43	57,5	137
141000.27	27	43	57,5	137

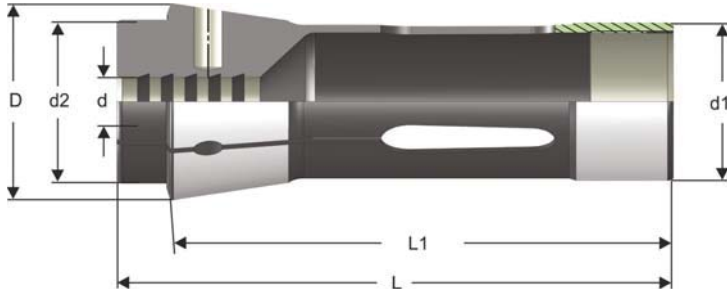

Sipariş Kodu Order Number	L	L1	d1	d2	D
143000.03	107,5	98,5	38,06	38	49
143000.04	107,5	98,5	38,06	38	49
143000.05	107,5	98,5	38,06	38	49
143000.06	107,5	98,5	38,06	38	49
143000.07	107,5	98,5	38,06	38	49
143000.08	107,5	98,5	38,06	38	49
143000.09	107,5	98,5	38,06	38	49
143000.10	107,5	98,5	38,06	38	49
143000.11	107,5	98,5	38,06	38	49
143000.12	107,5	98,5	38,06	38	49
143000.13	107,5	98,5	38,06	38	49
143000.14	107,5	98,5	38,06	38	49
143000.15	107,5	98,5	38,06	38	49
143000.16	107,5	98,5	38,06	38	49
143000.17	107,5	98,5	38,06	38	49

Sipariş Kodu Order Number	L	L1	d1	d2	D
143000.18	107,5	98,5	38,06	38	49
143000.19	107,5	98,5	38,06	38	49
143000.20	107,5	98,5	38,06	38	49
143000.21	107,5	98,5	38,06	38	49
143000.22	107,5	98,5	38,06	38	49
143000.23	107,5	98,5	38,06	38	49
143000.24	107,5	98,5	38,06	38	49
143000.25	107,5	98,5	38,06	38	49
143000.26	107,5	98,5	38,06	38	49
143000.27	107,5	98,5	38,06	38	49
143000.28	107,5	98,5	38,06	38	49
143000.29	107,5	98,5	38,06	38	49
143000.30	107,5	98,5	38,06	38	49
143000.31	107,5	98,5	38,06	38	49
143000.32	107,5	98,5	38,06	38	49

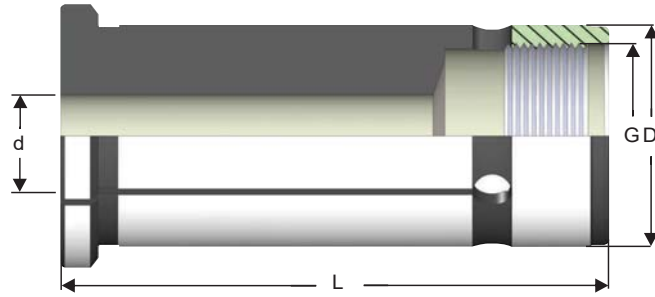

Sipariş Kodu Order Number	Ürün Adı Product Name	d	D	L	G
150020.03	RULMANLI TUTUCU PENSİ / PRECISION MILLING CHUCK COLLET	3	20	60	M16x1
150020.04	RULMANLI TUTUCU PENSİ / PRECISION MILLING CHUCK COLLET	4	20	60	M16x1
150020.05	RULMANLI TUTUCU PENSİ / PRECISION MILLING CHUCK COLLET	5	20	60	M16x1
150020.06	RULMANLI TUTUCU PENSİ / PRECISION MILLING CHUCK COLLET	6	20	60	M16x1
150020.07	RULMANLI TUTUCU PENSİ / PRECISION MILLING CHUCK COLLET	7	20	60	M16x1
150020.08	RULMANLI TUTUCU PENSİ / PRECISION MILLING CHUCK COLLET	8	20	60	M16x1
150020.09	RULMANLI TUTUCU PENSİ / PRECISION MILLING CHUCK COLLET	9	20	60	M16x1
150020.10	RULMANLI TUTUCU PENSİ / PRECISION MILLING CHUCK COLLET	10	20	60	M16x1
150020.11	RULMANLI TUTUCU PENSİ / PRECISION MILLING CHUCK COLLET	11	20	60	M16x1
150020.12	RULMANLI TUTUCU PENSİ / PRECISION MILLING CHUCK COLLET	12	20	60	M16x1
150020.13	RULMANLI TUTUCU PENSİ / PRECISION MILLING CHUCK COLLET	13	20	60	M16x1
150020.14	RULMANLI TUTUCU PENSİ / PRECISION MILLING CHUCK COLLET	14	20	60	M16x1
150020.15	RULMANLI TUTUCU PENSİ / PRECISION MILLING CHUCK COLLET	15	20	60	M16x1
150020.16	RULMANLI TUTUCU PENSİ / PRECISION MILLING CHUCK COLLET	16	20	60	M16x1

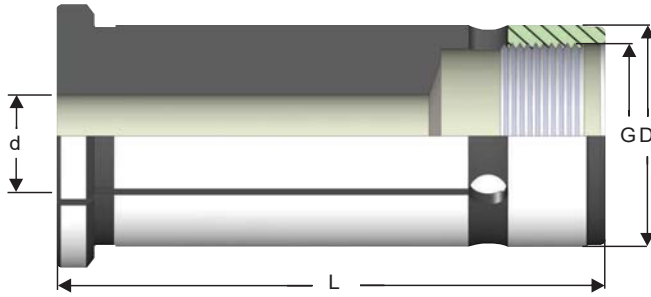

Sipariş Kodu Order Number	Ürün Adı Product Name	d	D	L	G
150025.03	RULMANLI TUTUCU PENSİ / PRECISION MILLING CHUCK COLLET	3	25	68	M21x1
150025.04	RULMANLI TUTUCU PENSİ / PRECISION MILLING CHUCK COLLET	4	25	68	M21x1
150025.05	RULMANLI TUTUCU PENSİ / PRECISION MILLING CHUCK COLLET	5	25	68	M21x1
150025.06	RULMANLI TUTUCU PENSİ / PRECISION MILLING CHUCK COLLET	6	25	68	M21x1
150025.07	RULMANLI TUTUCU PENSİ / PRECISION MILLING CHUCK COLLET	7	25	68	M21x1
150025.08	RULMANLI TUTUCU PENSİ / PRECISION MILLING CHUCK COLLET	8	25	68	M21x1
150025.09	RULMANLI TUTUCU PENSİ / PRECISION MILLING CHUCK COLLET	9	25	68	M21x1
150025.10	RULMANLI TUTUCU PENSİ / PRECISION MILLING CHUCK COLLET	10	25	68	M21x1
150025.11	RULMANLI TUTUCU PENSİ / PRECISION MILLING CHUCK COLLET	11	25	68	M21x1
150025.12	RULMANLI TUTUCU PENSİ / PRECISION MILLING CHUCK COLLET	12	25	68	M21x1
150025.13	RULMANLI TUTUCU PENSİ / PRECISION MILLING CHUCK COLLET	13	25	68	M21x1
150025.14	RULMANLI TUTUCU PENSİ / PRECISION MILLING CHUCK COLLET	14	25	68	M21x1
150025.15	RULMANLI TUTUCU PENSİ / PRECISION MILLING CHUCK COLLET	15	25	68	M21x1
150025.16	RULMANLI TUTUCU PENSİ / PRECISION MILLING CHUCK COLLET	16	25	68	M21x1
150025.17	RULMANLI TUTUCU PENSİ / PRECISION MILLING CHUCK COLLET	17	25	68	M21x1
150025.18	RULMANLI TUTUCU PENSİ / PRECISION MILLING CHUCK COLLET	18	25	68	M21x1
150025.19	RULMANLI TUTUCU PENSİ / PRECISION MILLING CHUCK COLLET	19	25	68	M21x1
150025.20	RULMANLI TUTUCU PENSİ / PRECISION MILLING CHUCK COLLET	20	25	68	M21x1

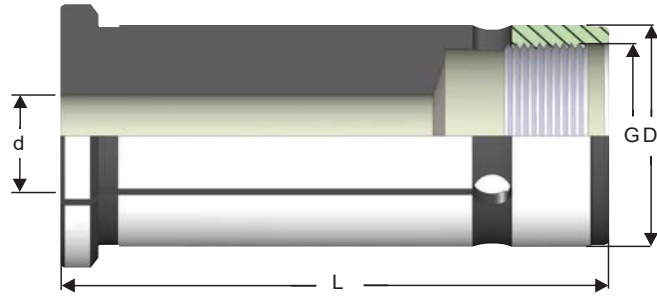

Sipariş Kodu Order Number	Ürün Adı Product Name	d	D	L	G
150032.03	RULMANLI TUTUCU PENSİ / PRECISION MILLING CHUCK COLLET	3	32	70	M26x1
150032.04	RULMANLI TUTUCU PENSİ / PRECISION MILLING CHUCK COLLET	4	32	70	M26x1
150032.05	RULMANLI TUTUCU PENSİ / PRECISION MILLING CHUCK COLLET	5	32	70	M26x1
150032.06	RULMANLI TUTUCU PENSİ / PRECISION MILLING CHUCK COLLET	6	32	70	M26x1
150032.07	RULMANLI TUTUCU PENSİ / PRECISION MILLING CHUCK COLLET	7	32	70	M26x1
150032.08	RULMANLI TUTUCU PENSİ / PRECISION MILLING CHUCK COLLET	8	32	70	M26x1
150032.09	RULMANLI TUTUCU PENSİ / PRECISION MILLING CHUCK COLLET	9	32	70	M26x1
150032.10	RULMANLI TUTUCU PENSİ / PRECISION MILLING CHUCK COLLET	10	32	70	M26x1
150032.11	RULMANLI TUTUCU PENSİ / PRECISION MILLING CHUCK COLLET	11	32	70	M26x1
150032.12	RULMANLI TUTUCU PENSİ / PRECISION MILLING CHUCK COLLET	12	32	70	M26x1
150032.13	RULMANLI TUTUCU PENSİ / PRECISION MILLING CHUCK COLLET	13	32	70	M26x1
150032.14	RULMANLI TUTUCU PENSİ / PRECISION MILLING CHUCK COLLET	14	32	70	M26x1
150032.15	RULMANLI TUTUCU PENSİ / PRECISION MILLING CHUCK COLLET	15	32	70	M26x1
150032.16	RULMANLI TUTUCU PENSİ / PRECISION MILLING CHUCK COLLET	16	32	70	M26x1
150032.17	RULMANLI TUTUCU PENSİ / PRECISION MILLING CHUCK COLLET	17	32	70	M26x1
150032.18	RULMANLI TUTUCU PENSİ / PRECISION MILLING CHUCK COLLET	18	32	70	M26x1
150032.19	RULMANLI TUTUCU PENSİ / PRECISION MILLING CHUCK COLLET	19	32	70	M26x1
150032.20	RULMANLI TUTUCU PENSİ / PRECISION MILLING CHUCK COLLET	20	32	70	M26x1
150032.21	RULMANLI TUTUCU PENSİ / PRECISION MILLING CHUCK COLLET	21	32	70	M26x1
150032.22	RULMANLI TUTUCU PENSİ / PRECISION MILLING CHUCK COLLET	22	32	70	M26x1
150032.23	RULMANLI TUTUCU PENSİ / PRECISION MILLING CHUCK COLLET	23	32	70	M26x1
150032.24	RULMANLI TUTUCU PENSİ / PRECISION MILLING CHUCK COLLET	24	32	70	M26x1
150032.25	RULMANLI TUTUCU PENSİ / PRECISION MILLING CHUCK COLLET	25	32	70	M26x1



DEĞERLİ
www.degerlimakina.com

DIN 6499

BAŞLIKSIZ ANAHTARSIZ ER SERİSİ TAKIMLAR

COLLET SET IN BOX ER SERIES WITHOUT WRENCH



Sipariş Kodu Order Number	Ürün Adı Product Name	Adet Piece	Ölçüler Contents
000426	426 PENS TAKIMI 426 COLLET SET İN BOX	8	3-4-5-6-7-8-9-10
000428	428 PENS TAKIMI 428 COLLET SET İN BOX	11	3-4-5-6-7-8-9-10-11-12-13
000430-1	430 PENS TAKIMI 430 COLLET SET İN BOX	14	3-4-5-6-7-8-9-10-11-12-13-14-15-16
000470-1	470 PENS TAKIMI 470 COLLET SET İN BOX	18	3-4-5-6-7-8-9-10-11-12-13-14-15-16-17-18-19-20
000472-1	472 PENS TAKIMI 472 COLLET SET İN BOX	23	4-5-6-7-8-9-10-11-12-13-14-15-16-17-18-19-20-21-22-23-24-25-26

DIN 6499

BAŞLIKSIZ ANAHTARLI ER SERİSİ TAKIMLAR
COLLET SET IN BOX ER SERIES WITH WRENCH

DEĞERLİ®
www.degerlimakina.com

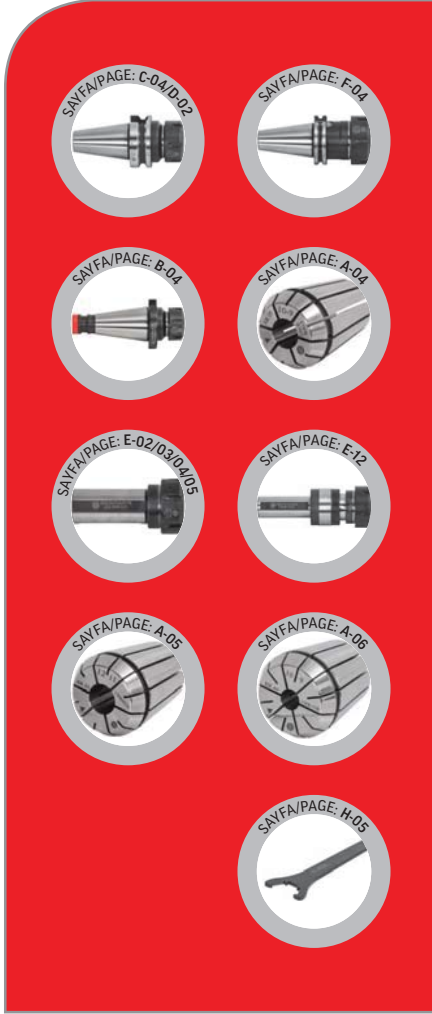

Sipariş Kodu Order Number	Ürün Adı Product Name	Adet Piece	Ölçüler Contents
000430	430 PENS TAKIMI 430 COLLET SET IN BOX	13	3-4-5-6-7-8-9-10-11-12-14-16 - 9042430
000470	470 PENS TAKIMI 470 COLLET SET IN BOX	15	3-4-5-6-7-8-9-10-11-12-14-16-18-20 - 9050470
000472	472 PENS TAKIMI 472 COLLET SET IN BOX	17	4-5-6-7-8-9-10-11-12-14-16-18-20-22-24-26 - 9063472



DEĞERLİ
www.degerlimakina.com

DIN 6388

BAŞLIKSIZ ANAHTARLI E TİPİ TAKIMLAR

COLLET SET IN BOX E SERIES WITH WRENCH



SAYFA/PAGE: B-03



SAYFA/PAGE: C-03



SAYFA/PAGE: F-03



SAYFA/PAGE: G-03/07



SAYFA/PAGE: H-04



Sipariş Kodu Order Number	Ürün Adı Product Name	Adet Piece	Ölçüler Contents
000415	415 PENS TAKIMI 415 COLLET SET İN BOX	15	3-4-5-6-7-8-9-10-11-12-13-14-15-16 - 904042
000440	440 PENS TAKIMI 440 COLLET SET İN BOX	15	3-4-5-6-7-8-9-10-11-12-14-16-18-20 - 904550
000462	462 PENS TAKIMI 462 COLLET SET İN BOX	17	4-5-6-7-8-9-10-11-12-14-16-18-20-22-24-25 - 905862
000467	467 PENS TAKIMI 467 COLLET SET İN BOX	17	5-6-7-8-10-12-14-16-18-20-22-24-25-28-30-32 - 906875
000468	468 PENS TAKIMI 468 COLLET SET İN BOX	21	6-7-8-9-10-12-14-16-18-20-22-24-25-28-30-32-34-36-38-40 - 908590



DIN 2080
ISO TUTUCULAR
ISO TOOLHOLDERS

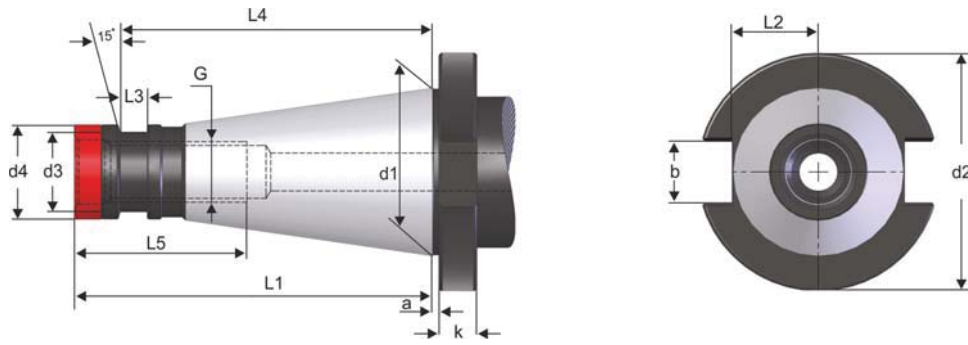

Ürün Adı Product Name	d1	a	b	k	G	d2	d3	d4	L1	L2	L3	L4	L5
ISO 30	31,75	1,6	16,1	8	M12	50	-	17,1	68,4	16,2	-	-	24
ISO 40	44,45	1,6	16,1	10	M16	63	21,1	25	93,4	22,5	7	82	32
ISO 50	69,85	3,2	25,7	12	M24	97,5	32	39,2	126,8	35,3	13,3	115	47

DIN 2080 / DIN 6391

6388 PENS BAŞLIĞI

6388 COLLET CHUCK

DEĞERLİ®

www.degerlimakina.com

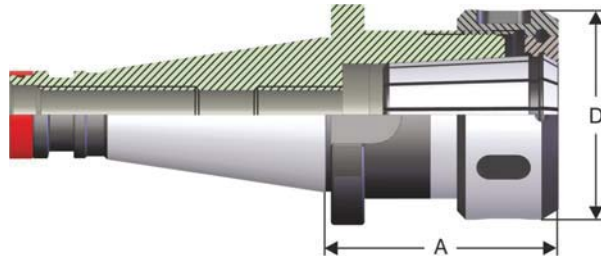

Sipariş Kodu Order Number	Ürün Adı Product Name	Kapasite Capacity	D	A
210415	ISO 30 - 415 PENS BAŞLIĞI / COLLET CHUCK	2-16 mm	43	50
210462	ISO 30 - 462 PENS BAŞLIĞI / COLLET CHUCK	2-25 mm	60	80
211415	ISO 40 - 415 PENS BAŞLIĞI / COLLET CHUCK	2-16 mm	43	55
211462	ISO 40 - 462 PENS BAŞLIĞI / COLLET CHUCK	2-25 mm	60	66
211467	ISO 40 - 467 PENS BAŞLIĞI / COLLET CHUCK	3-32 mm	72	95
215462	ISO 50 - 462 PENS BAŞLIĞI / COLLET CHUCK	2-25 mm	60	71
215467	ISO 50 - 467 PENS BAŞLIĞI / COLLET CHUCK	3-32 mm	72	73
215468	ISO 50 - 468 PENS BAŞLIĞI / COLLET CHUCK	3-40 mm	85	75



DEĞERLİ
www.degerlimakina.com

DIN 2080

DIN 6499 ER SERİSİ PENS BAŞLIĞI

DIN 6499 ER SERIES COLLET CHUCK

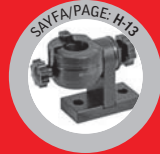
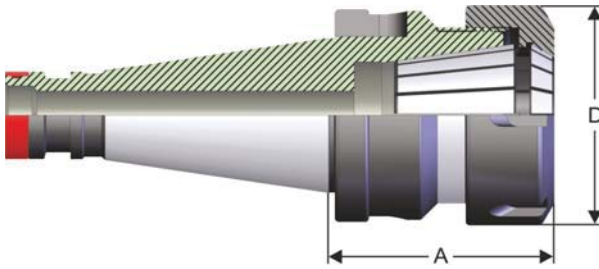

Sipariş Kodu Order Number	Ürün Adı Product Name	Kapasite Capacity	D	A
210430	ISO 30 - 430 ER 25 PENS BAŞLIĞI / COLLET CHUCK	2-16 mm	42	50
210470	ISO 30 - 470 ER 32 PENS BAŞLIĞI / COLLET CHUCK	2-20 mm	50	50
210472	ISO 30 - 472 ER 40 PENS BAŞLIĞI / COLLET CHUCK	2-26 mm	63	65
211430	ISO 40 - 430 ER 25 PENS BAŞLIĞI / COLLET CHUCK	2-16 mm	42	50
211470	ISO 40 - 470 ER 32 PENS BAŞLIĞI / COLLET CHUCK	2-20 mm	50	50
211472	ISO 40 - 472 ER 40 PENS BAŞLIĞI / COLLET CHUCK	2-26 mm	63	80
215470	ISO 50 - 470 ER 32 PENS BAŞLIĞI / COLLET CHUCK	2-20 mm	50	63
215472	ISO 50 - 472 ER 40 PENS BAŞLIĞI / COLLET CHUCK	2-26 mm	63	63

DIN 2080**DIN 6358 KOMBİNE TARAMA TUTUCUSU**

DIN 6358 COMBI SHELL MILL HOLDER

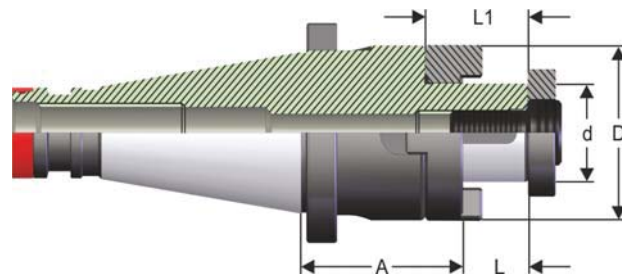
DEĞERLİ
www.degerlimakina.com

Sipariş Kodu Order Number	Ürün Adı Product Name	d h6	D	A	L	L1
223016	ISO 30 - K.T.B. 16 / COMBI SHELL MILL HOLDER	16	32	35	17	27
223022	ISO 30 - K.T.B. 22 / COMBI SHELL MILL HOLDER	22	40	35	19	31
223027	ISO 30 - K.T.B. 27 / COMBI SHELL MILL HOLDER	27	48	35	21	33
223032	ISO 30 - K.T.B. 32 / COMBI SHELL MILL HOLDER	32	58	50	24	38
224016	ISO 40 - K.T.B. 16 / COMBI SHELL MILL HOLDER	16	32	52	17	27
224022	ISO 40 - K.T.B. 22 / COMBI SHELL MILL HOLDER	22	40	52	19	31
224027	ISO 40 - K.T.B. 27 / COMBI SHELL MILL HOLDER	27	48	52	21	33
224032	ISO 40 - K.T.B. 32 / COMBI SHELL MILL HOLDER	32	58	52	24	38
224040	ISO 40 - K.T.B. 40 / COMBI SHELL MILL HOLDER	40	70	52	27	41
225016	ISO 50 - K.T.B. 16 / COMBI SHELL MILL HOLDER	16	32	55	17	27
225022	ISO 50 - K.T.B. 22 / COMBI SHELL MILL HOLDER	22	40	55	19	31
225027	ISO 50 - K.T.B. 27 / COMBI SHELL MILL HOLDER	27	48	55	21	33
225032	ISO 50 - K.T.B. 32 / COMBI SHELL MILL HOLDER	32	58	55	24	38
225040	ISO 50 - K.T.B. 40 / COMBI SHELL MILL HOLDER	40	70	55	27	41



DEĞERLİ
www.degerlimakina.com

DIN 2080

DIN 6357 ALIN KAMALI TARAMA TUTUCUSU

DIN 6357 SHELL MILL HOLDER

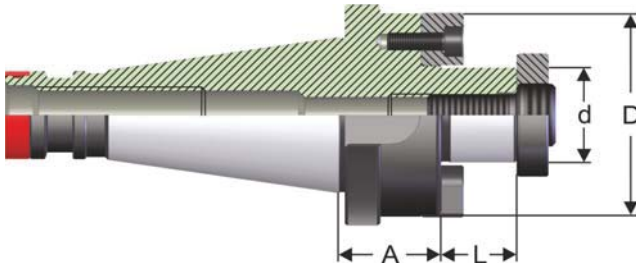

Sipariş Kodu Order Number	Ürün Adı Product Name	d h6	D	A	L
234016	ISO 40 - A.T.B. 16 / SHELL MILL HOLDER	16	38	30	17
234022	ISO 40 - A.T.B. 22 / SHELL MILL HOLDER	22	48	30	19
234027	ISO 40 - A.T.B. 27 / SHELL MILL HOLDER	27	58	30	21
234032	ISO 40 - A.T.B. 32 / SHELL MILL HOLDER	32	78	30	24
234040	ISO 40 - A.T.B. 40 / SHELL MILL HOLDER	40	88	30	27
235016	ISO 50 - A.T.B. 16 / SHELL MILL HOLDER	16	38	35	17
235022	ISO 50 - A.T.B. 22 / SHELL MILL HOLDER	22	48	35	19
235027	ISO 50 - A.T.B. 27 / SHELL MILL HOLDER	27	58	35	21
235032	ISO 50 - A.T.B. 32 / SHELL MILL HOLDER	32	78	40	24
235040	ISO 50 - A.T.B. 40 / SHELL MILL HOLDER	40	88	40	27
235060	ISO 50 - A.T.B. 60 / SHELL MILL HOLDER	60	128	55	40

DIN 2080**ISO 40 DIN 6359 VELDON TUTUCU - DIN 1835-B**
ISO 40 DIN 6359 END MILL HOLDER - DIN 1835-B**DEĞERLİ®**
www.degerlimakina.com

SAYFA/PAGE: H-21



SAYFA/PAGE: H-12



SAYFA/PAGE: H-13



58-60 HRC

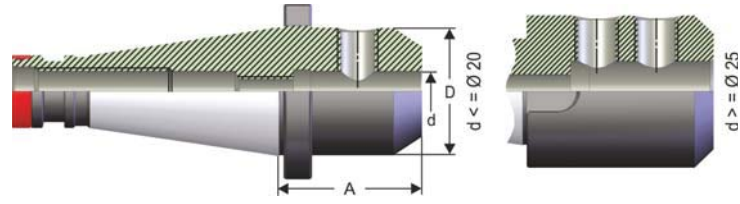

Sipariş Kodu Order Number	Ürün Adı Product Name	d h4	D	A
244006	ISO 40 VELDON / END MILL HOLDER	6	25	50
244008	ISO 40 VELDON / END MILL HOLDER	8	28	50
244010	ISO 40 VELDON / END MILL HOLDER	10	35	50
244012	ISO 40 VELDON / END MILL HOLDER	12	42	50
244014	ISO 40 VELDON / END MILL HOLDER	14	44	50
244016	ISO 40 VELDON / END MILL HOLDER	16	48	63
244018	ISO 40 VELDON / END MILL HOLDER	18	50	63
244020	ISO 40 VELDON / END MILL HOLDER	20	52	63
244025	ISO 40 VELDON / END MILL HOLDER	25	63	80
244032	ISO 40 VELDON / END MILL HOLDER	32	72	80
244040	ISO 40 VELDON / END MILL HOLDER	40	79	90



DEĞERLİ
www.degerlimakina.com

DIN 2080

ISO 50 DIN 6359 VELDON TUTUCU - DIN 1835-B

ISO 50 DIN 6359 END MILL HOLDER - DIN 1835-B

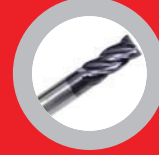
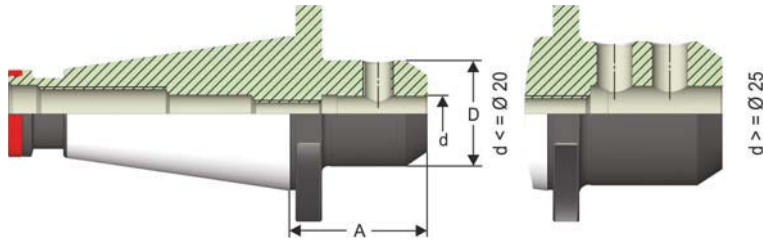

Sipariş Kodu Order Number	Ürün Adı Product Name	d h4	D	A
245006	ISO 50 VELDON / END MILL HOLDER	6	25	63
245008	ISO 50 VELDON / END MILL HOLDER	8	28	63
245010	ISO 50 VELDON / END MILL HOLDER	10	35	63
245012	ISO 50 VELDON / END MILL HOLDER	12	42	63
245014	ISO 50 VELDON / END MILL HOLDER	14	44	63
245016	ISO 50 VELDON / END MILL HOLDER	16	48	63
245018	ISO 50 VELDON / END MILL HOLDER	18	50	63
245020	ISO 50 VELDON / END MILL HOLDER	20	52	63
245025	ISO 50 VELDON / END MILL HOLDER	25	65	80
245032	ISO 50 VELDON / END MILL HOLDER	32	72	80
245040	ISO 50 VELDON / END MILL HOLDER	40	80	90

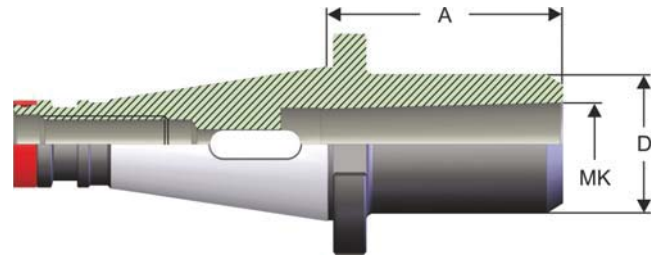
DIN 2080**KAMALI MORS ADAPTÖRÜ DIN 6383**
MORSE TAPER ADTOR TANG DIN 6383**DEĞERLİ**
www.degerlimakina.com

Sipariş Kodu Order Number	Ürün Adı Product Name	Mk Morse	A	D
253001	ISO 30 KAMALI MORS ADAPTÖRÜ / MORSE TAPER ADAPTOR TANG	1	50	25
253002	ISO 30 KAMALI MORS ADAPTÖRÜ / MORSE TAPER ADAPTOR TANG	2	50	32
253003	ISO 30 KAMALI MORS ADAPTÖRÜ / MORSE TAPER ADAPTOR TANG	3	75	40
254001	ISO 40 KAMALI MORS ADAPTÖRÜ / MORSE TAPER ADAPTOR TANG	1	50	25
254002	ISO 40 KAMALI MORS ADAPTÖRÜ / MORSE TAPER ADAPTOR TANG	2	50	32
254003	ISO 40 KAMALI MORS ADAPTÖRÜ / MORSE TAPER ADAPTOR TANG	3	65	40
254004	ISO 40 KAMALI MORS ADAPTÖRÜ / MORSE TAPER ADAPTOR TANG	4	95	48
255001	ISO 50 KAMALI MORS ADAPTÖRÜ / MORSE TAPER ADAPTOR TANG	1	45	25
255002	ISO 50 KAMALI MORS ADAPTÖRÜ / MORSE TAPER ADAPTOR TANG	2	60	32
255003	ISO 50 KAMALI MORS ADAPTÖRÜ / MORSE TAPER ADAPTOR TANG	3	65	40
255004	ISO 50 KAMALI MORS ADAPTÖRÜ / MORSE TAPER ADAPTOR TANG	4	70	48
255005	ISO 50 KAMALI MORS ADAPTÖRÜ / MORSE TAPER ADAPTOR TANG	5	105	63



DEĞERLİ
www.degerlimakina.com

DIN 2080

ÇEKTİRMELİ MORS ADAPTÖRÜ DIN 6364

MORSE TAPER ADTOR DRAWBAR DIN 6364

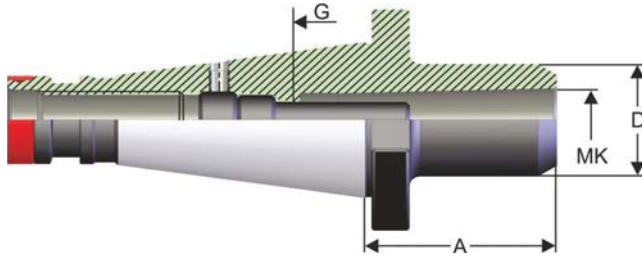

Sipariş Kodu Order Number	Ürün Adı Product Name	Mk Morse	A	D	G
264001	ISO 40 ÇEK. MORS ADAPTÖRÜ / MORSE TAPER ADAPTOR DRAWBAR	1	50	25	M6
264002	ISO 40 ÇEK. MORS ADAPTÖRÜ / MORSE TAPER ADAPTOR DRAWBAR	2	50	32	M10
264003	ISO 40 ÇEK. MORS ADAPTÖRÜ / MORSE TAPER ADAPTOR DRAWBAR	3	65	40	M12
264004	ISO 40 ÇEK. MORS ADAPTÖRÜ / MORSE TAPER ADAPTOR DRAWBAR	4	95	48	M16
265001	ISO 50 ÇEK. MORS ADAPTÖRÜ / MORSE TAPER ADAPTOR DRAWBAR	1	60	25	M6
265002	ISO 50 ÇEK. MORS ADAPTÖRÜ / MORSE TAPER ADAPTOR DRAWBAR	2	60	32	M10
265003	ISO 50 ÇEK. MORS ADAPTÖRÜ / MORSE TAPER ADAPTOR DRAWBAR	3	65	40	M12
265004	ISO 50 ÇEK. MORS ADAPTÖRÜ / MORSE TAPER ADAPTOR DRAWBAR	4	65	48	M16
265005	ISO 50 ÇEK. MORS ADAPTÖRÜ / MORSE TAPER ADAPTOR DRAWBAR	5	120	63	M20

DIN 2080

MANDREN BAŞLIĞI DIN 238

DRILL CHUCK ADAPTOR DIN 238

DEĞERLİ®

www.degerlimakina.com

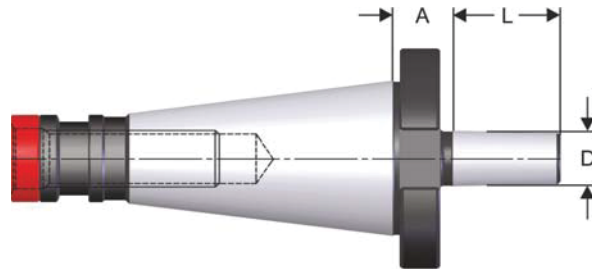

Sipariş Kodu Order Number	Ürün Adı Product Name	D	A	L
273012	ISO 30 MANDREN ADAPTÖRÜ / DRILL CHUCK ADAPTOR	B12	13,5	18,5
273016	ISO 30 MANDREN ADAPTÖRÜ / DRILL CHUCK ADAPTOR	B16	15,5	24
274012	ISO 40 MANDREN ADAPTÖRÜ / DRILL CHUCK ADAPTOR	B12	15	18,5
274016	ISO 40 MANDREN ADAPTÖRÜ / DRILL CHUCK ADAPTOR	B16	17	24
274018	ISO 40 MANDREN ADAPTÖRÜ / DRILL CHUCK ADAPTOR	B18	17	32
275016	ISO 50 MANDREN ADAPTÖRÜ / DRILL CHUCK ADAPTOR	B16	20	24
275018	ISO 50 MANDREN ADAPTÖRÜ / DRILL CHUCK ADAPTOR	B18	20	32



DEĞERLİ
www.degerlimakina.com

DIN 2080

ÇEKTİRME CİVATALI ADAPTÖR

ADAPTÖR SLEEVES

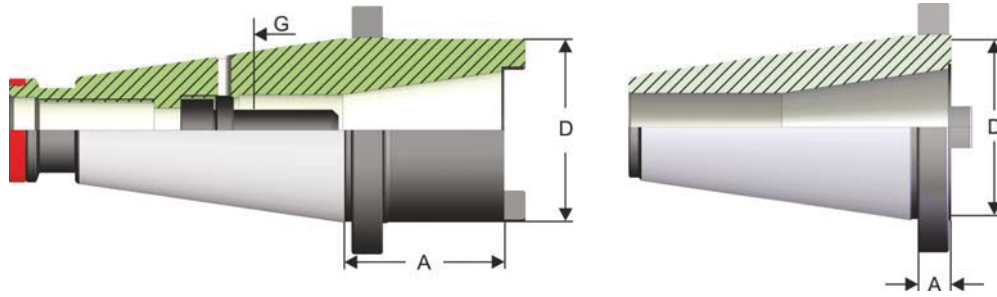

Sipariş Kodu
Order Number

Ürün Adı
Product Name

D

A

G

285040

ISO 50 / ISO 40 UZUN ADAPTÖR / ADAPTÖR SLEEVES

60

70

M16

285040.1

ISO 50 / ISO 40 KISA ADAPTÖR / ADAPTÖR SLEEVES

16

70

-

DIN 2080**DIN 6388-B PENS TAKIMLARI**
DIN 6388-B COLLET SET IN BOX**DEĞERLİ®**
www.degerlimakina.com

SAYFA/PAGE: H-18



SAYFA/PAGE: H-12



SAYFA/PAGE: B-03



SAYFA/PAGE: A-08/10/11/2



SAYFA/PAGE: H-04



Sipariş Kodu Order Number	Ürün Adı Product Name	Adet Piece	Ölçüler Contents
293415	ISO 30 - 415 PENS TAKIMI 415 COLLET SET IN BOX	16	3-4-5-6-7-8-9-10-11-12-13-14-15-16 - 904042 - 210415
293462	ISO 30 - 462 PENS TAKIMI 462 COLLET SET IN BOX	18	4-5-6-7-8-9-10-11-12-14-16-18-20-22-24-25 - 905862 - 210462
294415	ISO 40 - 415 PENS TAKIMI 415 COLLET SET IN BOX	16	3-4-5-6-7-8-9-10-11-12-13-14-15-16 - 904042 - 211415
294462	ISO 40 - 462 PENS TAKIMI 462 COLLET SET IN BOX	18	4-5-6-7-8-9-10-11-12-14-16-18-20-22-24-25 - 905862 - 211462
294467	ISO 40 - 467 PENS TAKIMI 467 COLLET SET IN BOX	18	5-6-7-8-10-12-14-16-18-20-22-24-25-28-30-32 - 906875 - 211467
295462	ISO 50 - 462 PENS TAKIMI 462 COLLET SET IN BOX	18	4-5-6-7-8-9-10-11-12-14-16-18-20-22-24-25 - 905862 - 215462
295467	ISO 50 - 467 PENS TAKIMI 467 COLLET SET IN BOX	18	5-6-7-8-10-12-14-16-18-20-22-24-25-28-30-32 - 906875 - 215467
295468	ISO 50 - 468 PENS TAKIMI 468 COLLET SET IN BOX	22	6-7-8-9-10-12-14-16-18-20-22-24-25-28-30-32-34-36-38-40 - 908590 - 215468



DEĞERLİ
www.degerlimakina.com

DIN 6499 / ER SERİSİ TAKIMLAR

DIN 6499 / COLLET SET IN BOX ER SERIES

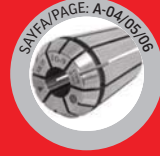

Sipariş Kodu Order Number	Ürün Adı Product Name	Adet Piece	Ölçüler Contents
293430	ISO 30 - 430 PENS TAKIMI 430 COLLET SET IN BOX	14	3-4-5-6-7-8-9-10-11-12-14-16 - 9042430 - 210430
293470	ISO 30 - 470 PENS TAKIMI 470 COLLET SET IN BOX	16	3-4-5-6-7-8-9-10-11-12-14-16-18-20 - 9050470 - 210470
293472	ISO 30 - 472 PENS TAKIMI 472 COLLET SET IN BOX	18	4-5-6-7-8-9-10-11-12-14-16-18-20-22-24-26 - 9063472 - 210472
294430	ISO 40 - 430 PENS TAKIMI 430 COLLET SET IN BOX	14	3-4-5-6-7-8-9-10-11-12-14-16 - 9042430 - 211430
294470	ISO 40 - 470 PENS TAKIMI 470 COLLET SET IN BOX	16	3-4-5-6-7-8-9-10-11-12-14-16-18-20 - 9050470 - 211470
294472	ISO 40 - 472 PENS TAKIMI 472 COLLET SET IN BOX	18	4-5-6-7-8-9-10-11-12-14-16-18-20-22-24-26 - 9063472 - 211472
295470	ISO 50 - 470 PENS TAKIMI 470 COLLET SET IN BOX	16	3-4-5-6-7-8-9-10-11-12-14-16-18-20 - 9050470 - 215470
295472	ISO 50 - 472 PENS TAKIMI 472 COLLET SET IN BOX	18	4-5-6-7-8-9-10-11-12-14-16-18-20-22-24-26 - 9063472 - 215472



JIS B 6339 (MAS 403 BT)
BT TUTUCULAR
BT TOOLHOLDERS



DEĞERLİ
www.degerlimakina.com

JIS B 6339 (MAS 403 BT)

BT ŞAFT ÖLÇÜLERİ

BT TOOLHOLDERS NORM

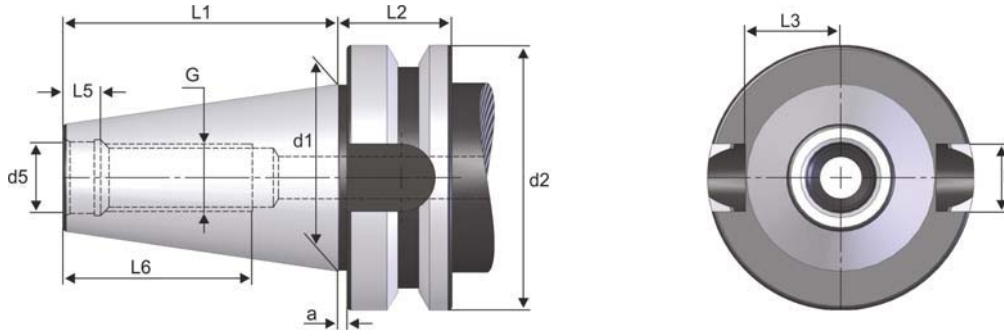

STANDART
BALANS
G 6,3
15000 min⁻¹



58-60 HRC



Ürün Adı Product Name	d1	G	d5	d2	a	L1	L2	L3	L5	L6	b
BT 30	31,75	M12	12,5	46	2	48,4	22	16,3	7	24	16,1
BT 40	44,45	M16	17	63	2	65,4	27	22,5	8,2	32	16,1
BT 50	69,85	M24	25	100	3	101,8	38	35,3	11	47	25,7

JIS B 6339 (MAS 403 BT)

DIN 6391 PENS BAŞLIĞI DIN 6388 PENS

DIN 6391 COLLET CHUCK DIN 6388 COLLET

DEĞERLİ®

www.degerlimakina.com

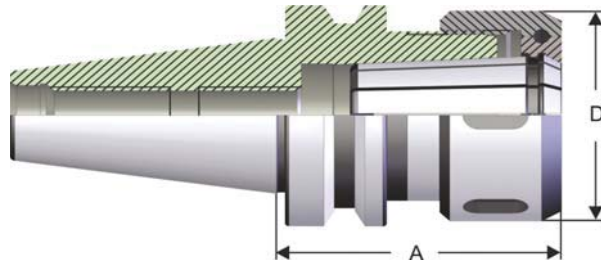

Sipariş Kodu Order Number	Ürün Adı Product Name	Kapasite Capacity	D	A
310415	BT 30 - 415 PENS BAŞLIĞI / COLLET CHUCK	2-16 mm	43	60
310462	BT 30 - 462 PENS BAŞLIĞI / COLLET CHUCK	2-25 mm	60	80
311415	BT 40 - 415 PENS BAŞLIĞI / COLLET CHUCK	2-16 mm	43	70
311462	BT 40 - 462 PENS BAŞLIĞI / COLLET CHUCK	2-25 mm	60	70
311467	BT 40 - 467 PENS BAŞLIĞI / COLLET CHUCK	3-32 mm	72	90
315462	BT 50 - 462 PENS BAŞLIĞI / COLLET CHUCK	2-25 mm	60	85
315467	BT 50 - 467 PENS BAŞLIĞI / COLLET CHUCK	3-32 mm	72	90
315468	BT 50 - 468 PENS BAŞLIĞI / COLLET CHUCK	3-40 mm	85	100



DEĞERLİ
www.degerlimakina.com

JIS B 6339 (MAS 403 BT)

DIN 6499 ER SERİSİ PENS BAŞLIĞI

DIN 6499 ER SERIES COLLET CHUCK

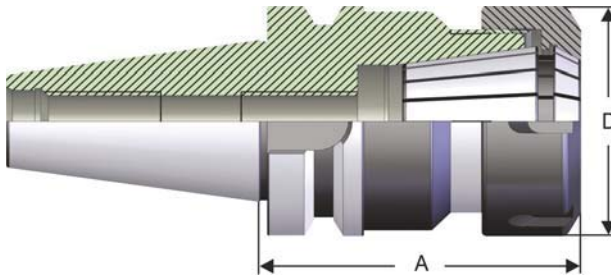

Sipariş Kodu Order Number	Ürün Adı Product Name	Kapasite Capacity	D	A
310426	BT 30 - 426 ER 16 PENS BAŞLIĞI / COLLET CHUCK	2-10 mm	32	70
310430	BT 30 - 430 ER 25 PENS BAŞLIĞI / COLLET CHUCK	2-16 mm	42	70
310470	BT 30 - 470 ER 32 PENS BAŞLIĞI / COLLET CHUCK	2-20 mm	50	70
310472	BT 30 - 472 ER 40 PENS BAŞLIĞI / COLLET CHUCK	2-26 mm	63	70
311426	BT 40 - 426 ER 16 PENS BAŞLIĞI / COLLET CHUCK	2-10 mm	32	63
311430	BT 40 - 430 ER 25 PENS BAŞLIĞI / COLLET CHUCK	2-16 mm	42	60
311470	BT 40 - 470 ER 32 PENS BAŞLIĞI / COLLET CHUCK	2-20 mm	50	70
311472	BT 40 - 472 ER 40 PENS BAŞLIĞI / COLLET CHUCK	2-26 mm	63	80
315426	BT 50 - 426 ER 16 PENS BAŞLIĞI / COLLET CHUCK	2-10 mm	32	70
315430	BT 50 - 430 ER 25 PENS BAŞLIĞI / COLLET CHUCK	2-16 mm	42	70
315470	BT 50 - 470 ER 32 PENS BAŞLIĞI / COLLET CHUCK	2-20 mm	50	70
315472	BT 50 - 472 ER 40 PENS BAŞLIĞI / COLLET CHUCK	2-26 mm	63	80

JIS B 6339 (MAS 403 BT)

DIN 6499 ER SERİSİ PENS BAŞLIĞI
DIN 6499 ER SERIES COLLET CHUCK

DEĞERLİ®
www.degerlimakina.com

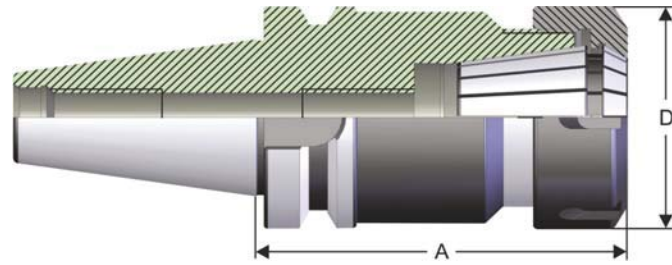

Sipariş Kodu Order Number	Ürün Adı Product Name	Kapasite Capacity	D	A
310426-1	BT 30 - 426 ER 16 PENS BAŞLIĞI / COLLET CHUCK	2-10 mm	32	100
310426-2	BT 30 - 426 ER 16 PENS BAŞLIĞI MİNİ / COLLET CHUCK	2-10 mm	22	100
310430-1	BT 30 - 430 ER 25 PENS BAŞLIĞI / COLLET CHUCK	2-16 mm	42	100
310470-1	BT 30 - 470 ER 32 PENS BAŞLIĞI / COLLET CHUCK	2-20 mm	50	100
310472-1	BT 30 - 472 ER 40 PENS BAŞLIĞI / COLLET CHUCK	2-26 mm	63	100
312426	BT 40 - 426 ER 16 PENS BAŞLIĞI / COLLET CHUCK	2-10 mm	32	100
312426-1	BT 40 - 426 ER 16 PENS BAŞLIĞI MİNİ / COLLET CHUCK	2-10 mm	22	100
312430	BT 40 - 430 ER 25 PENS BAŞLIĞI / COLLET CHUCK	2-16 mm	42	100
312470	BT 40 - 470 ER 32 PENS BAŞLIĞI / COLLET CHUCK	2-20 mm	50	100
312472	BT 40 - 472 ER 40 PENS BAŞLIĞI / COLLET CHUCK	2-26 mm	63	100
316426	BT 50 - 426 ER 16 PENS BAŞLIĞI / COLLET CHUCK	2-10 mm	32	100
316430	BT 50 - 430 ER 25 PENS BAŞLIĞI / COLLET CHUCK	2-16 mm	42	100
316470	BT 50 - 470 ER 32 PENS BAŞLIĞI / COLLET CHUCK	2-20 mm	50	100
316472	BT 50 - 472 ER 40 PENS BAŞLIĞI / COLLET CHUCK	2-26 mm	63	100



DEĞERLİ
www.degerlimakina.com

JIS B 6339 (MAS 403 BT)

DIN 6499 ER SERİSİ PENS BAŞLIĞI

DIN 6499 ER SERIES COLLET CHUCK

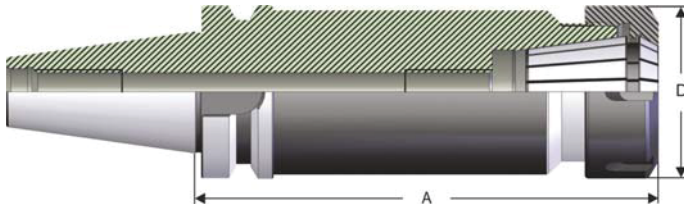

Sipariş Kodu Order Number	Ürün Adı Product Name	Kapasite Capacity	D	A
310426-3	BT 30 - 426 ER 16 PENS BAŞLIĞI / COLLET CHUCK	2-10 mm	32	160
313426	BT 40 - 426 ER 16 PENS BAŞLIĞI / COLLET CHUCK	2-10 mm	32	160
313426-1	BT 40 - 426 ER 16 PENS BAŞLIĞI MİNİ / COLLET CHUCK	2-10 mm	22	160
313430	BT 40 - 430 ER 25 PENS BAŞLIĞI / COLLET CHUCK	2-16 mm	42	160
313470	BT 40 - 470 ER 32 PENS BAŞLIĞI / COLLET CHUCK	2-20 mm	50	160
313472	BT 40 - 472 ER 40 PENS BAŞLIĞI / COLLET CHUCK	2-26 mm	63	160
317426	BT 50 - 426 ER 16 PENS BAŞLIĞI / COLLET CHUCK	2-10 mm	32	160
317426-1	BT 50 - 426 ER 16 PENS BAŞLIĞI MİNİ / COLLET CHUCK	2-10 mm	22	160
317430	BT 50 - 430 ER 25 PENS BAŞLIĞI / COLLET CHUCK	2-16 mm	42	160
317470	BT 50 - 470 ER 32 PENS BAŞLIĞI / COLLET CHUCK	2-20 mm	50	160
317472	BT 50 - 472 ER 40 PENS BAŞLIĞI / COLLET CHUCK	2-26 mm	63	160

JIS B 6339 (MAS 403 BT)

DIN 6499 HASSAS AYARLANABİLİR PENS BAŞLIĞI

DIN 6499 ADJUSTABLE TOOL HOOLDER

DEĞERLİ®

www.degerlimakina.com

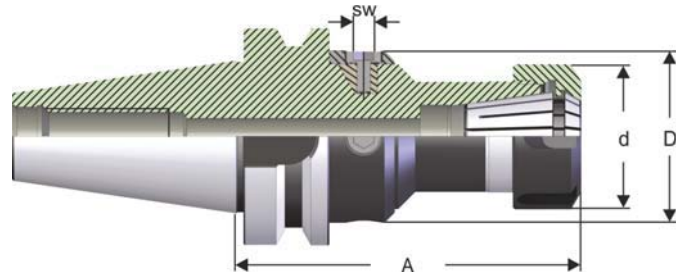
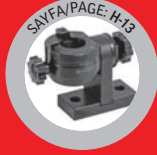

Sipariş Kodu Order Number	Ürün Adı Product Name	Kapasite Capacity	D	A	d	SW
314430	BT 40 - 430 ER 25 HAS.AYAR. PENS BAŞLIĞI / ADJUSTABLE TOOL HOOLDER	2-16 mm	50	90	42	5
314470	BT 40 - 470 ER 32 HAS.AYAR. PENS BAŞLIĞI / ADJUSTABLE TOOL HOOLDER	2-20 mm	50	100	50	5
314472	BT 40 - 472 ER 40 HAS.AYAR. PENS BAŞLIĞI / ADJUSTABLE TOOL HOOLDER	2-26 mm	60	105	63	5
318470	BT 50 - 470 ER 32 HAS.AYAR. PENS BAŞLIĞI / ADJUSTABLE TOOL HOOLDER	2-20 mm	50	110	50	5
318472	BT 50 - 472 ER 40 HAS.AYAR. PENS BAŞLIĞI / ADJUSTABLE TOOL HOOLDER	2-26 mm	60	115	63	5



DEĞERLİ
www.degerlimakina.com

JIS B 6339 (MAS 403 BT)

RULMANLI PENS BAŞLIĞI

PRECISION MILLING CHUCK

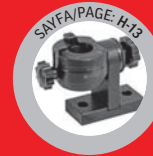
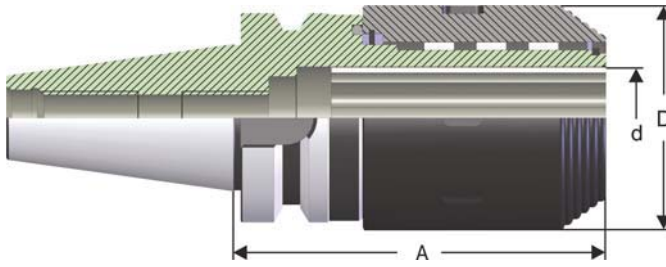

Sipariş Kodu Order Number	Ürün Adı Product Name	Kapasite Capacity (d)	A	D
318420	BT 40 - RULMANLI PENS BAŞLIĞI / PRECISION MILLING CHUCK	6-20 mm	75	49
318432	BT 40 - RULMANLI PENS BAŞLIĞI / PRECISION MILLING CHUCK	6-32 mm	90	68
319520	BT 50 - RULMANLI PENS BAŞLIĞI / PRECISION MILLING CHUCK	6-20 mm	90	49
319532	BT 50 - RULMANLI PENS BAŞLIĞI / PRECISION MILLING CHUCK	6-32 mm	95	68

JIS B 6339 (MAS 403 BT)
DIN 6358 KOMBİNE TARAMA TUTUCUSU
DIN 6358 COMBI SHELL MILL HOLDER

DEĞERLİ
www.degerlimakina.com

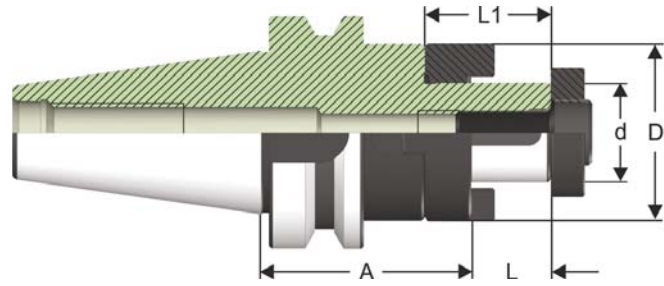

Sipariş Kodu Order Number	Ürün Adı Product Name	d h6	D	A	L	L1
323016	BT 30 - K.T.B. 16 / COMBI SHELL MILL HOLDER	16	32	45	17	27
323022	BT 30 - K.T.B. 22 / COMBI SHELL MILL HOLDER	22	40	47	19	31
323027	BT 30 - K.T.B. 27 / COMBI SHELL MILL HOLDER	27	48	49	21	33
324016	BT 40 - K.T.B. 16 / COMBI SHELL MILL HOLDER	16	32	55	17	27
324022	BT 40 - K.T.B. 22 / COMBI SHELL MILL HOLDER	22	40	55	19	31
324027	BT 40 - K.T.B. 27 / COMBI SHELL MILL HOLDER	27	48	55	21	33
324032	BT 40 - K.T.B. 32 / COMBI SHELL MILL HOLDER	32	58	60	24	38
324040	BT 40 - K.T.B. 40 / COMBI SHELL MILL HOLDER	40	70	60	27	41
325016	BT 50 - K.T.B. 16 / COMBI SHELL MILL HOLDER	16	32	70	17	27
325022	BT 50 - K.T.B. 22 / COMBI SHELL MILL HOLDER	22	40	70	19	31
325027	BT 50 - K.T.B. 27 / COMBI SHELL MILL HOLDER	27	48	70	21	33
325032	BT 50 - K.T.B. 32 / COMBI SHELL MILL HOLDER	32	58	70	24	38
325040	BT 50 - K.T.B. 40 / COMBI SHELL MILL HOLDER	40	70	70	27	41



DEĞERLİ
www.degerlimakina.com

JIS B 6339 (MAS 403 BT)

DIN 6358 KOMBİNE TARAMA TUTUCUSU

DIN 6358 COMBI SHELL MILL HOLDER

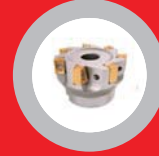
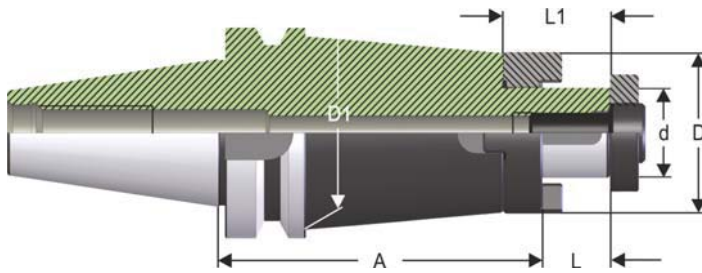

Sipariş Kodu Order Number	Ürün Adı Product Name	d h6	D	A	L	L1	D1
324116	BT 40 - K.T.B. 16 / COMBI SHELL MILL HOLDER	16	32	100	17	27	38
324122	BT 40 - K.T.B. 22 / COMBI SHELL MILL HOLDER	22	40	100	19	31	48
324127	BT 40 - K.T.B. 27 / COMBI SHELL MILL HOLDER	27	48	100	21	33	58
324132	BT 40 - K.T.B. 32 / COMBI SHELL MILL HOLDER	32	58	100	24	38	61
324140	BT 40 - K.T.B. 40 / COMBI SHELL MILL HOLDER	40	70	100	27	41	70
325116	BT 50 - K.T.B. 16 / COMBI SHELL MILL HOLDER	16	32	100	17	27	38
325122	BT 50 - K.T.B. 22 / COMBI SHELL MILL HOLDER	22	40	100	19	31	48
325127	BT 50 - K.T.B. 27 / COMBI SHELL MILL HOLDER	27	48	100	21	33	58
325132	BT 50 - K.T.B. 32 / COMBI SHELL MILL HOLDER	32	58	100	24	38	68
325140	BT 50 - K.T.B. 40 / COMBI SHELL MILL HOLDER	40	70	100	27	41	80

JIS B 6339 (MAS 403 BT)
DIN 6358 KOMBİNE TARAMA TUTUCUSU
DIN 6358 COMBI SHELL MILL HOLDER

DEĞERLİ
www.degerlimakina.com

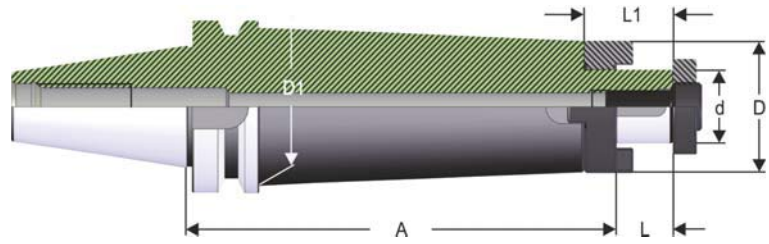
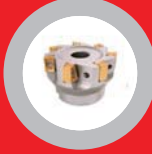

Sipariş Kodu Order Number	Ürün Adı Product Name	d h6	D	A	L	L1	D1
324116.1	BT 40 - K.T.B. 16 / COMBI SHELL MILL HOLDER	16	32	160	17	27	38
324122.1	BT 40 - K.T.B. 22 / COMBI SHELL MILL HOLDER	22	40	160	19	31	48
324127.1	BT 40 - K.T.B. 27 / COMBI SHELL MILL HOLDER	27	48	160	21	33	58
324132.1	BT 40 - K.T.B. 32 / COMBI SHELL MILL HOLDER	32	58	160	24	38	61
324140.1	BT 40 - K.T.B. 40 / COMBI SHELL MILL HOLDER	40	70	160	27	41	70
325116.1	BT 50 - K.T.B. 16 / COMBI SHELL MILL HOLDER	16	32	160	17	27	38
325122.1	BT 50 - K.T.B. 22 / COMBI SHELL MILL HOLDER	22	40	160	19	31	48
325127.1	BT 50 - K.T.B. 27 / COMBI SHELL MILL HOLDER	27	48	160	21	33	58
325132.1	BT 50 - K.T.B. 32 / COMBI SHELL MILL HOLDER	32	58	160	24	38	68
325140.1	BT 50 - K.T.B. 40 / COMBI SHELL MILL HOLDER	40	70	160	27	41	80



DEĞERLİ
www.degerlimakina.com

JIS B 6339 (MAS 403 BT)

DIN 6357 ALIN KAMALI TARAMA TUTUCUSU

DIN 6357 SHELL MILL HOLDER

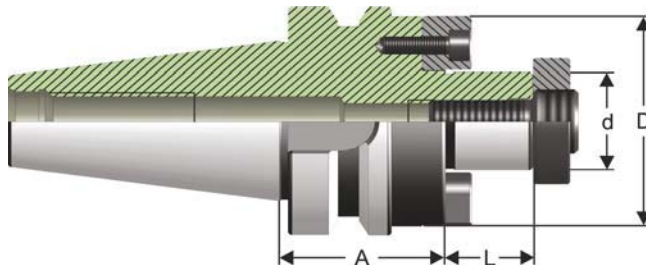

Sipariş Kodu Order Number	Ürün Adı Product Name	d h6	D	A	L
333016	BT 30 - A.T.B. 16 / SHELL MILL HOLDER	16	38	40	17
333022	BT 30 - A.T.B. 22 / SHELL MILL HOLDER	22	48	40	19
333027	BT 30 - A.T.B. 27 / SHELL MILL HOLDER	27	58	40	21
334016	BT 40 - A.T.B. 16 / SHELL MILL HOLDER	16	38	40	17
334022	BT 40 - A.T.B. 22 / SHELL MILL HOLDER	22	48	40	19
334027	BT 40 - A.T.B. 27 / SHELL MILL HOLDER	27	58	40	21
334032	BT 40 - A.T.B. 32 / SHELL MILL HOLDER	32	78	50	24
334040	BT 40 - A.T.B. 40 / SHELL MILL HOLDER	40	88	50	27
335016	BT 50 - A.T.B. 16 / SHELL MILL HOLDER	16	38	55	17
335022	BT 50 - A.T.B. 22 / SHELL MILL HOLDER	22	48	55	19
335027	BT 50 - A.T.B. 27 / SHELL MILL HOLDER	27	58	55	21
335032	BT 50 - A.T.B. 32 / SHELL MILL HOLDER	32	78	55	24
335040	BT 50 - A.T.B. 40 / SHELL MILL HOLDER	40	88	55	27
335060	BT 50 - A.T.B. 60 / SHELL MILL HOLDER	60	128	88	40

JIS B 6339 (MAS 403 BT)

DIN 6357 ALIN KAMALI TARAMA TUTUCUSU

DIN 6357 SHELL MILL HOLDER

DEĞERLİ®

www.degerlimakina.com

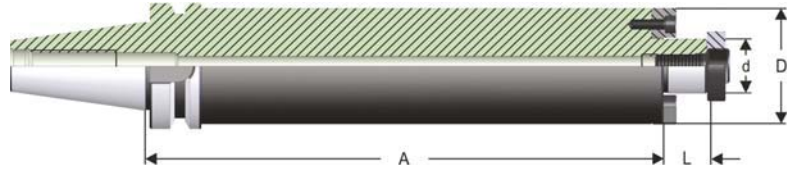

Sipariş Kodu Order Number	Ürün Adı Product Name	d h6	D	A	L
334322	BT 40 - A.T.B. 22 / SHELL MILL HOLDER	22	61	250	19
334327	BT 40 - A.T.B. 27 / SHELL MILL HOLDER	27	61	250	21
334332	BT 40 - A.T.B. 32 / SHELL MILL HOLDER	32	78	250	24
335322	BT 50 - A.T.B. 22 / SHELL MILL HOLDER	22	61	250	19
335327	BT 50 - A.T.B. 27 / SHELL MILL HOLDER	27	61	250	21
335332	BT 50 - A.T.B. 32 / SHELL MILL HOLDER	32	78	250	24



DEĞERLİ
www.degerlimakina.com

JIS B 6339 (MAS 403 BT)

BT 30 DIN 6359 VELDON TUTUCU - DIN 1835-B

BT 30 DIN 6359 END MILL HOLDER - DIN 1835-B

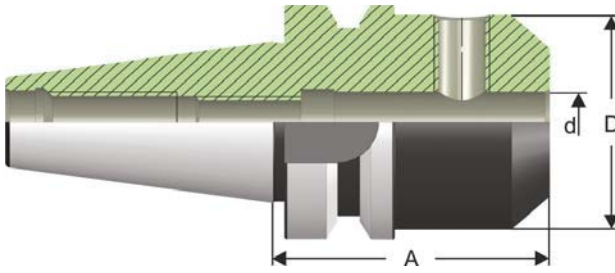

Sipariş Kodu Order Number	Ürün Adı Product Name	d h4	D	A
343006	BT 30 VELDON / END MILL HOLDER	6	25	50
343008	BT 30 VELDON / END MILL HOLDER	8	28	50
343010	BT 30 VELDON / END MILL HOLDER	10	35	50
343012	BT 30 VELDON / END MILL HOLDER	12	42	50
343014	BT 30 VELDON / END MILL HOLDER	14	44	63
343016	BT 30 VELDON / END MILL HOLDER	16	48	63
343018	BT 30 VELDON / END MILL HOLDER	18	50	63
343020	BT 30 VELDON / END MILL HOLDER	20	52	63

JIS B 6339 (MAS 403 BT)

BT 40 DIN 6359 VELDON TUTUCU - DIN 1835-B

BT 40 DIN 6359 END MILL HOLDER - DIN 1835-B

DEĞERLİ®

www.degerlimakina.com

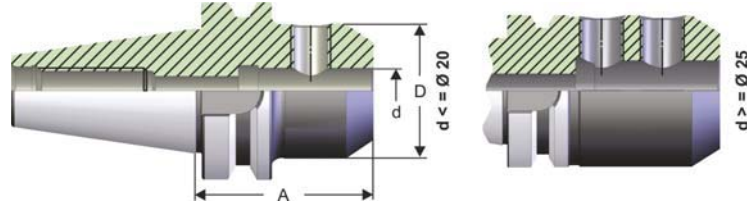

Sipariş Kodu Order Number	Ürün Adı Product Name	d h4	D	A
344006	BT 40 VELDON / END MILL HOLDER	6	25	50
344008	BT 40 VELDON / END MILL HOLDER	8	28	50
344010	BT 40 VELDON / END MILL HOLDER	10	35	63
344012	BT 40 VELDON / END MILL HOLDER	12	42	63
344014	BT 40 VELDON / END MILL HOLDER	14	44	63
344016	BT 40 VELDON / END MILL HOLDER	16	48	63
344018	BT 40 VELDON / END MILL HOLDER	18	50	63
344020	BT 40 VELDON / END MILL HOLDER	20	52	63
344025	BT 40 VELDON / END MILL HOLDER	25	63	90
344032	BT 40 VELDON / END MILL HOLDER	32	72	100
344040	BT 40 VELDON / END MILL HOLDER	40	79	120



DEĞERLİ
www.degerlimakina.com

JIS B 6339 (MAS 403 BT)

BT 40 DIN 6359 VELDON TUTUCU - DIN 1835-B

BT 40 DIN 6359 END MILL HOLDER - DIN 1835-B

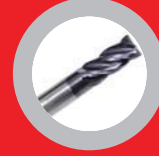
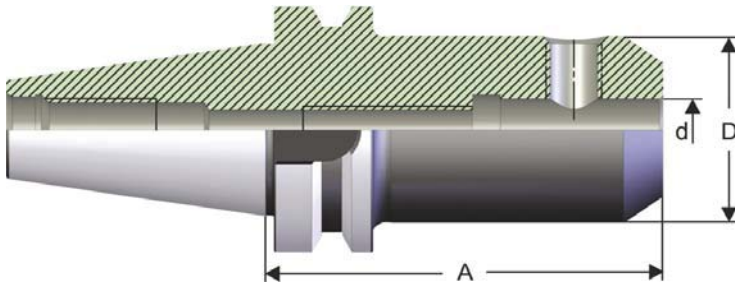

Sipariş Kodu Order Number	Ürün Adı Product Name	d h4	D	A
344106	BT 40 VELDON / END MILL HOLDER	6	25	100
344108	BT 40 VELDON / END MILL HOLDER	8	28	100
344110	BT 40 VELDON / END MILL HOLDER	10	35	100
344112	BT 40 VELDON / END MILL HOLDER	12	42	100
344114	BT 40 VELDON / END MILL HOLDER	14	44	100
344116	BT 40 VELDON / END MILL HOLDER	16	48	100
344118	BT 40 VELDON / END MILL HOLDER	18	50	100
344120	BT 40 VELDON / END MILL HOLDER	20	52	100

JIS B 6339 (MAS 403 BT)

BT 40 DIN 6359 VELDON TUTUCU - DIN 1835-B

BT 40 DIN 6359 END MILL HOLDER - DIN 1835-B

DEĞERLİ
www.degerlimakina.com

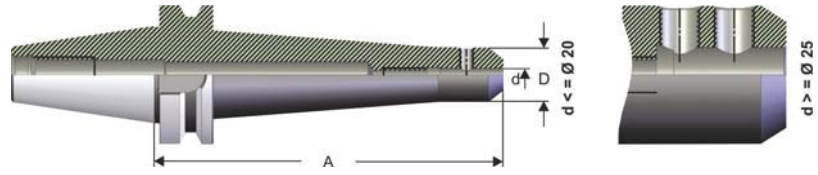
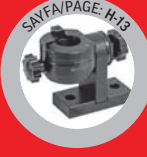

Sipariş Kodu Order Number	Ürün Adı Product Name	d h4	D	A
344106.1	BT 40 VELDON / END MILL HOLDER	6	25	160
344108.1	BT 40 VELDON / END MILL HOLDER	8	28	160
344110.1	BT 40 VELDON / END MILL HOLDER	10	35	160
344112.1	BT 40 VELDON / END MILL HOLDER	12	42	160
344114.1	BT 40 VELDON / END MILL HOLDER	14	44	160
344116.1	BT 40 VELDON / END MILL HOLDER	16	48	160
344118.1	BT 40 VELDON / END MILL HOLDER	18	50	160
344120.1	BT 40 VELDON / END MILL HOLDER	20	52	160
344125.1	BT 40 VELDON / END MILL HOLDER	25	63	160
344132.1	BT 40 VELDON / END MILL HOLDER	32	72	160



DEĞERLİ
www.degerlimakina.com

JIS B 6339 (MAS 403 BT)

BT 50 DIN 6359 VELDON TUTUCU - DIN 1835-B

BT 50 DIN 6359 END MILL HOLDER - DIN 1835-B

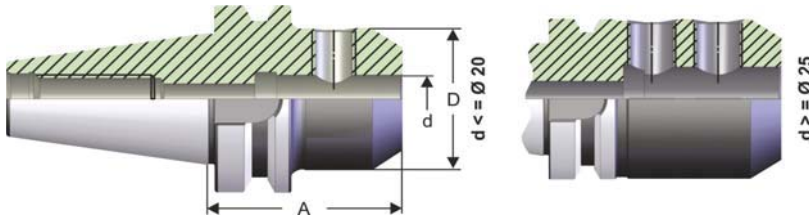

Sipariş Kodu Order Number	Ürün Adı Product Name	d h4	D	A
345006	BT 50 VELDON / END MILL HOLDER	6	25	63
345008	BT 50 VELDON / END MILL HOLDER	8	28	63
345010	BT 50 VELDON / END MILL HOLDER	10	35	63
345012	BT 50 VELDON / END MILL HOLDER	12	42	80
345014	BT 50 VELDON / END MILL HOLDER	14	44	80
345016	BT 50 VELDON / END MILL HOLDER	16	48	80
345018	BT 50 VELDON / END MILL HOLDER	18	50	80
345020	BT 50 VELDON / END MILL HOLDER	20	52	80
345025	BT 50 VELDON / END MILL HOLDER	25	65	100
345032	BT 50 VELDON / END MILL HOLDER	32	72	105
345040	BT 50 VELDON / END MILL HOLDER	40	80	110

JIS B 6339 (MAS 403 BT)

BT 50 DIN 6359 VELDON TUTUCU - DIN 1835-B

BT 50 DIN 6359 END MILL HOLDER - DIN 1835-B

DEĞERLİ®
www.degerlimakina.com

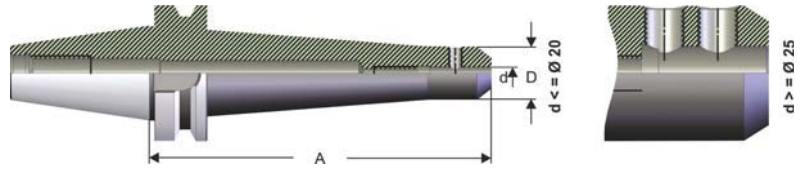
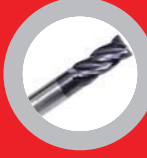

Sipariş Kodu Order Number	Ürün Adı Product Name	d h4	D	A
345106	BT 50 VELDON / END MILL HOLDER	6	25	160
345108	BT 50 VELDON / END MILL HOLDER	8	28	160
345110	BT 50 VELDON / END MILL HOLDER	10	35	160
345112	BT 50 VELDON / END MILL HOLDER	12	42	160
345116	BT 50 VELDON / END MILL HOLDER	16	48	160
345120	BT 50 VELDON / END MILL HOLDER	20	52	160
345125	BT 50 VELDON / END MILL HOLDER	25	65	160
345132	BT 50 VELDON / END MILL HOLDER	32	72	160
345140	BT 50 VELDON / END MILL HOLDER	40	80	160



DEĞERLİ
www.degerlimakina.com

JIS B 6339 (MAS 403 BT)

KAMALI MORS ADAPTÖRÜ DIN 6383

MORSE TAPER ADTOR TANG DIN 6383

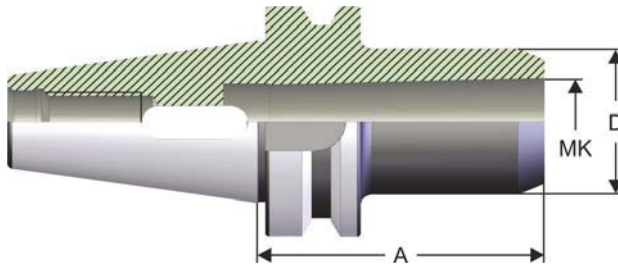

Sipariş Kodu Order Number	Ürün Adı Product Name	Mk Morse	D	A
353001	BT 30 KAMALI MORS ADAPTÖRÜ / MORSE TAPER ADAPTOR TANG	1	25	45
353002	BT 30 KAMALI MORS ADAPTÖRÜ / MORSE TAPER ADAPTOR TANG	2	32	60
353003	BT 30 KAMALI MORS ADAPTÖRÜ / MORSE TAPER ADAPTOR TANG	3	40	75
354001	BT 40 KAMALI MORS ADAPTÖRÜ / MORSE TAPER ADAPTOR TANG	1	25	50
354002	BT 40 KAMALI MORS ADAPTÖRÜ / MORSE TAPER ADAPTOR TANG	2	32	50
354003	BT 40 KAMALI MORS ADAPTÖRÜ / MORSE TAPER ADAPTOR TANG	3	40	70
354004	BT 40 KAMALI MORS ADAPTÖRÜ / MORSE TAPER ADAPTOR TANG	4	48	95
355001	BT 50 KAMALI MORS ADAPTÖRÜ / MORSE TAPER ADAPTOR TANG	1	25	45
355002	BT 50 KAMALI MORS ADAPTÖRÜ / MORSE TAPER ADAPTOR TANG	2	32	60
355003	BT 50 KAMALI MORS ADAPTÖRÜ / MORSE TAPER ADAPTOR TANG	3	40	65
355004	BT 50 KAMALI MORS ADAPTÖRÜ / MORSE TAPER ADAPTOR TANG	4	48	95
355005	BT 50 KAMALI MORS ADAPTÖRÜ / MORSE TAPER ADAPTOR TANG	5	63	105

JIS B 6339 (MAS 403 BT)

ÇEKTİRMELİ MORS ADAPTÖRÜ DIN 6364

MORSE TAPER ADTOR DRAWBAR DIN 6364

DEĞERLİ®

www.degerlimakina.com

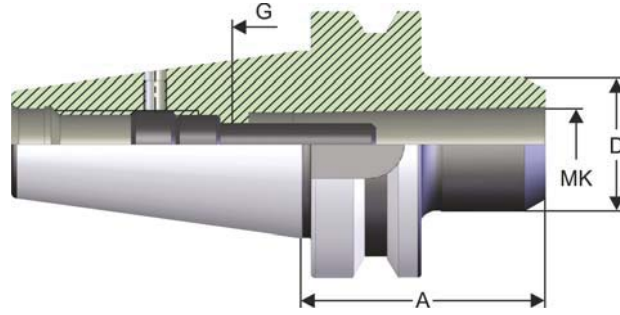

Sipariş Kodu Order Number	Ürün Adı Product Name	Mk Morse	D	A	G
364001	BT 40 ÇEK. MORS ADAPTÖRÜ / MORSE TAPER ADAPTOR DRAWBAR	1	25	50	M6
364002	BT 40 ÇEK. MORS ADAPTÖRÜ / MORSE TAPER ADAPTOR DRAWBAR	2	32	55	M10
364003	BT 40 ÇEK. MORS ADAPTÖRÜ / MORSE TAPER ADAPTOR DRAWBAR	3	40	70	M12
364004	BT 40 ÇEK. MORS ADAPTÖRÜ / MORSE TAPER ADAPTOR DRAWBAR	4	48	95	M16
365001	BT 50 ÇEK. MORS ADAPTÖRÜ / MORSE TAPER ADAPTOR DRAWBAR	1	25	45	M6
365002	BT 50 ÇEK. MORS ADAPTÖRÜ / MORSE TAPER ADAPTOR DRAWBAR	2	32	60	M10
365003	BT 50 ÇEK. MORS ADAPTÖRÜ / MORSE TAPER ADAPTOR DRAWBAR	3	40	65	M12
365004	BT 50 ÇEK. MORS ADAPTÖRÜ / MORSE TAPER ADAPTOR DRAWBAR	4	48	85	M16
365005	BT 50 ÇEK. MORS ADAPTÖRÜ / MORSE TAPER ADAPTOR DRAWBAR	5	63	118	M20



DEĞERLİ
www.degerlimakina.com

JIS B 6339 (MAS 403 BT)

MANDREN BAŞLIĞI DIN 238

DRILL CHUCK ADAPTOR DIN 238

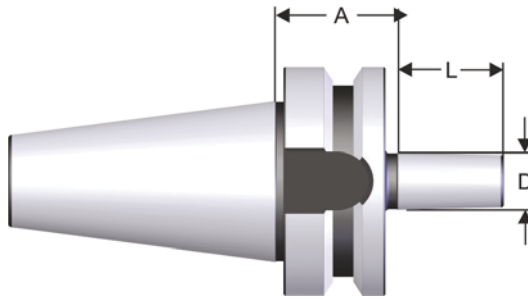

Sipariş Kodu
Order Number

Ürün Adı
Product Name

D

A

L

373012

BT 30 MANDREN ADAPTÖRÜ / DRILL CHUCK ADAPTOR

B12

25

18,5

373016

BT 30 MANDREN ADAPTÖRÜ / DRILL CHUCK ADAPTOR

B16

25

24

374012

BT 40 MANDREN ADAPTÖRÜ / DRILL CHUCK ADAPTOR

B12

32

18,5

374016

BT 40 MANDREN ADAPTÖRÜ / DRILL CHUCK ADAPTOR

B16

32

24

374018

BT 40 MANDREN ADAPTÖRÜ / DRILL CHUCK ADAPTOR

B18

32

32

375016

BT 50 MANDREN ADAPTÖRÜ / DRILL CHUCK ADAPTOR

B16

43

24

375018

BT 50 MANDREN ADAPTÖRÜ / DRILL CHUCK ADAPTOR

B18

43

32

JIS B 6339 (MAS 403 BT)

NC TİPİ MANDREN TUTUCU

NC DRILL CHUCK

DEĞERLİ®

www.degerlimakina.com

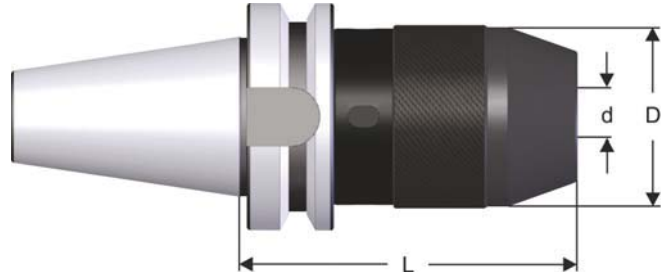

Sipariş Kodu Order Number	Ürün Adı Product Name	Kapasite Capacity (d)	D	L
374116	BT 40 NC MANDREN TUTUCU / NC DRILL CHUCK	1-16	51	97
375116	BT 50 NC MANDREN TUTUCU / NC DRILL CHUCK	1-16	51	108



DEĞERLİ
www.degerlimakina.com

JIS B 6339 (MAS 403 BT)

KLAVUZ ÇEKME BAŞLIĞI GİRİŞ VE ÇIKIŞ KOMPANZİYELİ

QUICK-CHANGE TAPPING CHUCKS WITH LENGTH COMPENSATION

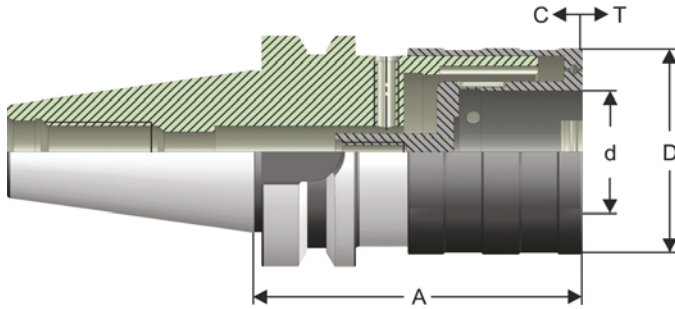

Sipariş Kodu Order Number	Ürün Adı Product Name	d	A	D	C	T
376214	BT 30 M2 - M14 EM.TİP KLV.ÇEK.BAŞ. / QUICK-CHANGE TAPPING CHUCK	19	64	38	7	7
376524	BT 30 M5 - M24 EM.TİP KLV.ÇEK.BAŞ. / QUICK-CHANGE TAPPING CHUCK	31	95	54	12	12
377214	BT 40 M2 - M14 EM.TİP KLV.ÇEK.BAŞ. / QUICK-CHANGE TAPPING CHUCK	19	67	38	7	7
377524	BT 40 M5 - M24 EM.TİP KLV.ÇEK.BAŞ. / QUICK-CHANGE TAPPING CHUCK	31	93	54	12	12
3771436	BT 40 M14 - M36 EM.TİP KLV.ÇEK.BAŞ. / QUICK-CHANGE TAPPING CHUCK	48	136	78	17,5	17,5
378214	BT 50 M2 - M14 EM.TİP KLV.ÇEK.BAŞ. / QUICK-CHANGE TAPPING CHUCK	19	82	38	7	7
378524	BT 50 M5 - M24 EM.TİP KLV.ÇEK.BAŞ. / QUICK-CHANGE TAPPING CHUCK	31	102	54	12	12
3781436	BT 50 M14 - M36 EM.TİP KLV.ÇEK.BAŞ. / QUICK-CHANGE TAPPING CHUCK	48	142	78	17,5	17,5

JIS B 6339 (MAS 403 BT)
VİDALI FREZE TAKIM TUTUCULARI
SET HOLDERS FOR SCREW MILLING CUTTERS

DEĞERLİ
www.degerlimakina.com

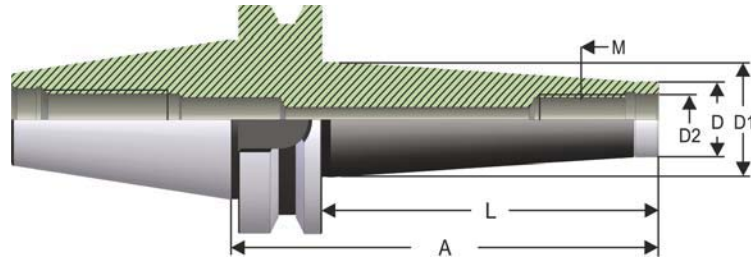

Sipariş Kodu Order Number	Ürün Adı Product Name	M	D	D1	A	L	D2
384008	BT 40 VİDALI TAKIM TUTUCU / SET HOLDERS FOR SCREW MILLING CUTTERS	M8	13	23	77	50	8,5
384008.1	BT 40 VİDALI TAKIM TUTUCU / SET HOLDERS FOR SCREW MILLING CUTTERS	M8	13	25	127	100	8,5
384008.2	BT 40 VİDALI TAKIM TUTUCU / SET HOLDERS FOR SCREW MILLING CUTTERS	M8	13	30	177	150	8,5
384010	BT 40 VİDALI TAKIM TUTUCU / SET HOLDERS FOR SCREW MILLING CUTTERS	M10	18	23	77	50	10,5
384010.1	BT 40 VİDALI TAKIM TUTUCU / SET HOLDERS FOR SCREW MILLING CUTTERS	M10	18	32	127	100	10,5
384010.2	BT 40 VİDALI TAKIM TUTUCU / SET HOLDERS FOR SCREW MILLING CUTTERS	M10	18	36	177	150	10,5
384012	BT 40 VİDALI TAKIM TUTUCU / SET HOLDERS FOR SCREW MILLING CUTTERS	M12	21	25	77	50	12,5
384012.1	BT 40 VİDALI TAKIM TUTUCU / SET HOLDERS FOR SCREW MILLING CUTTERS	M12	21	32	127	100	12,5
384012.2	BT 40 VİDALI TAKIM TUTUCU / SET HOLDERS FOR SCREW MILLING CUTTERS	M12	21	40	177	150	12,5
384016	BT 40 VİDALI TAKIM TUTUCU / SET HOLDERS FOR SCREW MILLING CUTTERS	M16	29	34	102	75	17
384016.0	BT 40 VİDALI TAKIM TUTUCU / SET HOLDERS FOR SCREW MILLING CUTTERS	M16	29	-	52	25	17
384016.1	BT 40 VİDALI TAKIM TUTUCU / SET HOLDERS FOR SCREW MILLING CUTTERS	M16	29	40	152	125	17



DEĞERLİ
www.degerlimakina.com

JIS B 6339 (MAS 403 BT)

VİDALI FREZE TAKIM TUTUCULARI

SET HOLDERS FOR SCREW MILLING CUTTERS

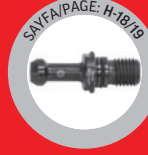
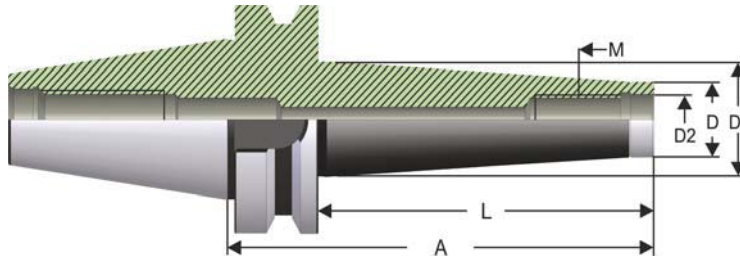

Sipariş Kodu Order Number	Ürün Adı Product Name	M	D	D1	A	L	D2
385008	BT 50 VİDALI TAKIM TUTUCU / SET HOLDERS FOR SCREW MILLING CUTTERS	M8	13	25	138	100	8,5
385008.1	BT 50 VİDALI TAKIM TUTUCU / SET HOLDERS FOR SCREW MILLING CUTTERS	M8	13	30	188	150	8,5
385010	BT 50 VİDALI TAKIM TUTUCU / SET HOLDERS FOR SCREW MILLING CUTTERS	M10	18	32	138	100	10,5
385010.1	BT 50 VİDALI TAKIM TUTUCU / SET HOLDERS FOR SCREW MILLING CUTTERS	M10	18	36	188	150	10,5
385012	BT 50 VİDALI TAKIM TUTUCU / SET HOLDERS FOR SCREW MILLING CUTTERS	M12	21	33	138	100	12,5
385012.1	BT 50 VİDALI TAKIM TUTUCU / SET HOLDERS FOR SCREW MILLING CUTTERS	M12	21	40	188	150	12,5
385016	BT 50 VİDALI TAKIM TUTUCU / SET HOLDERS FOR SCREW MILLING CUTTERS	M16	29	36	138	100	17
385016.1	BT 50 VİDALI TAKIM TUTUCU / SET HOLDERS FOR SCREW MILLING CUTTERS	M16	29	42	188	150	17

JIS B 6339 (MAS 403 BT)

ÖZEL TAKIM YAPMAK İÇİN YUMUŞAK BARA

BORİNG BAR BLANKS FOR PRODUCING SPECIAL TOOL

DEĞERLİ®

www.degerlimakina.com

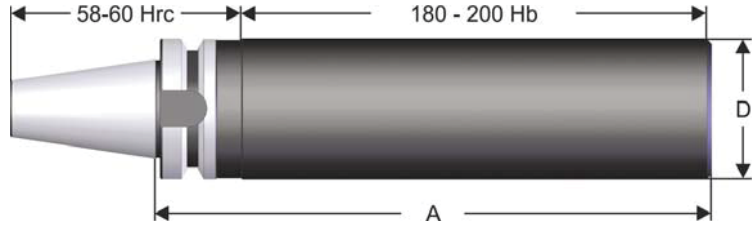

Sipariş Kodu
Order Number

Ürün Adı
Product Name

D

A

394000

BT 40 ÖZEL TAKIM HAM BARA / BORİNG BAR BLANKS

63

250

395000

BT 50 ÖZEL TAKIM HAM BARA / BORİNG BAR BLANKS

97

315



DEĞERLİ
www.degerlimakina.com

JIS B 6339 (MAS 403 BT)

DIN 6388-B PENS TAKIMLARI

DIN 6388-B COLLET SET IN BOX

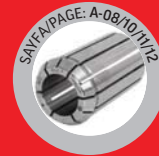

Sipariş Kodu Order Number	Ürün Adı Product Name	Adet Piece	Ölçüler Contents
393415	BT 30 - 415 PENS TAKIMI 415 COLLET SET IN BOX	16	3-4-5-6-7-8-9-10-11-12-13-14-15-16 - 904042 - 310415
393462	BT 30 - 462 PENS TAKIMI 462 COLLET SET IN BOX	18	4-5-6-7-8-9-10-11-12-14-16-18-20-22-24-25 - 905862 - 310462
394415	BT 40 - 415 PENS TAKIMI 415 COLLET SET IN BOX	16	3-4-5-6-7-8-9-10-11-12-13-14-15-16 - 904042 - 311415
394462	BT 40 - 462 PENS TAKIMI 462 COLLET SET IN BOX	18	4-5-6-7-8-9-10-11-12-14-16-18-20-22-24-25 - 905862 - 311462
394467	BT 40 - 467 PENS TAKIMI 467 COLLET SET IN BOX	18	5-6-7-8-10-12-14-16-18-20-22-24-25-28-30-32 - 906875 - 311467
395462	BT 50 - 462 PENS TAKIMI 462 COLLET SET IN BOX	18	4-5-6-7-8-9-10-11-12-14-16-18-20-22-24-25 - 905862 - 315462
395467	BT 50 - 467 PENS TAKIMI 467 COLLET SET IN BOX	18	5-6-7-8-10-12-14-16-18-20-22-24-25-28-30-32 - 906875 - 315467
395468	BT 50 - 468 PENS TAKIMI 468 COLLET SET IN BOX	22	6-7-8-9-10-12-14-16-18-20-22-24-25-28-30-32-34-36-38-40 - 908590 - 315468

JIS B 6339 (MAS 403 BT)

DIN 6499 / ER SERİSİ TAKIMLAR

DIN 6499 / COLLET SET IN BOX ER SERIES

DEĞERLİ®

www.degerlimakina.com



Sipariş Kodu Order Number	Ürün Adı Product Name	Adet Piece	Ölçüler Contents
393430	BT 30 - 430 PENS TAKIMI 430 COLLET SET İN BOX	14	3-4-5-6-7-8-9-10-11-12-14-16 - 9042430 - 310430
393470	BT 30 - 470 PENS TAKIMI 470 COLLET SET İN BOX	16	3-4-5-6-7-8-9-10-11-12-14-16-18-20 - 9050470 - 310470
393472	BT 30 - 472 PENS TAKIMI 472 COLLET SET İN BOX	18	4-5-6-7-8-9-10-11-12-14-16-18-20-22-24-26 - 9063472 - 310472
394430	BT 40 - 430 PENS TAKIMI 430 COLLET SET İN BOX	14	3-4-5-6-7-8-9-10-11-12-14-16 - 9042430 - 311430
394470	BT 40 - 470 PENS TAKIMI 470 COLLET SET İN BOX	16	3-4-5-6-7-8-9-10-11-12-14-16-18-20 - 9050470 - 311470
394472	BT 40 - 472 PENS TAKIMI 472 COLLET SET İN BOX	18	4-5-6-7-8-9-10-11-12-14-16-18-20-22-24-26 - 9063472 - 311472
395430	BT 50 - 430 PENS TAKIMI 430 COLLET SET İN BOX	14	3-4-5-6-7-8-9-10-11-12-14-16 - 9042430 - 315430
395470	BT 50 - 470 PENS TAKIMI 470 COLLET SET İN BOX	16	3-4-5-6-7-8-9-10-11-12-14-16-18-20 - 9050470 - 315470
395472	BT 50 - 472 PENS TAKIMI 472 COLLET SET İN BOX	18	4-5-6-7-8-9-10-11-12-14-16-18-20-22-24-26 - 9063472 - 315472



DEĞERLİ
www.degerlimakina.com

JIS B 6339 (MAS 403 BT)

RULMANLI PENS TAKIMI

PRECISION MILLING CHUCK SET IN BOX



Sipariş Kodu Order Number	Ürün Adı Product Name	Adet Piece	Ölçüler Contents
398420	BT 40 RULMANLI PENS TAKIMI PRECISION MILLING CHUCK SET IN BOX	7	6-8-10-12-16 - 904550 - 318420
398432	BT 40 RULMANLI PENS TAKIMI PRECISION MILLING CHUCK SET IN BOX	9	6-8-10-12-16-20-25- 906875 - 318432
399520	BT 50 RULMANLI PENS TAKIMI PRECISION MILLING CHUCK SET IN BOX	7	6-8-10-12-16 - 904550 - 319520
399532	BT 50 RULMANLI PENS TAKIMI PRECISION MILLING CHUCK SET IN BOX	9	6-8-10-12-16-20-25- 906875 - 319532



JIS B 6339 (MAS 403 BBT)
BBT TUTUCULAR
BBT TOOLHOLDERS



DEĞERLİ
www.degerlimakina.com

JIS B 6339 (MAS 403 BBT)

DIN 6499 ER SERİSİ PENS BAŞLIĞI

DIN 6499 ER SERIES COLLET CHUCK

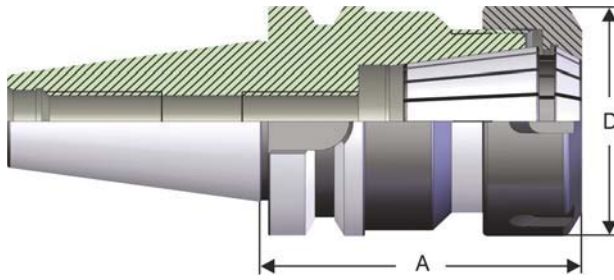

Sipariş Kodu Order Number	Ürün Adı Product Name	Kapasite Capacity	D	A
311426.DGP	BBT - 40 ER-16 426 PENS BAŞLIĞI / COLLET CHUCK	2-10 mm	32	63
311430.DGP	BBT - 40 ER-25 430 PENS BAŞLIĞI / COLLET CHUCK	2-16 mm	42	60
311470.DGP	BBT - 40 ER-32 470 PENS BAŞLIĞI / COLLET CHUCK	2-20 mm	50	70
311472.DGP	BBT - 40 ER-40 472 PENS BAŞLIĞI / COLLET CHUCK	2-26 mm	63	80
315426.DGP	BBT - 50 ER-16 426 PENS BAŞLIĞI / COLLET CHUCK	2-10 mm	32	70
315430.DGP	BBT - 50 ER-25 430 PENS BAŞLIĞI / COLLET CHUCK	2-16 mm	42	70
315470.DGP	BBT - 50 ER-32 470 PENS BAŞLIĞI / COLLET CHUCK	2-20 mm	50	70
315472.DGP	BBT - 50 ER-40 472 PENS BAŞLIĞI / COLLET CHUCK	2-26 mm	63	80

JIS B 6339 (MAS 403 BBT)

DIN 6499 ER SERİSİ PENS BAŞLIĞI

DIN 6499 ER SERIES COLLET CHUCK

DEĞERLİ®

www.degerlimakina.com

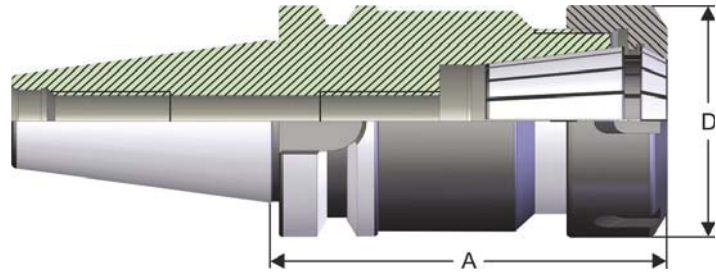

Sipariş Kodu Order Number	Ürün Adı Product Name	Kapasite Capacity	D	A
312426.DGP	BBT 40 - 426 ER 16 PENS BAŞLIĞI / COLLET CHUCK	2-10 mm	32	100
312426-1.DGP	BBT 40 - 426 ER 16 PENS BAŞLIĞI MİNİ / COLLET CHUCK	2-10 mm	22	100
312430.DGP	BBT 40 - 430 ER 25 PENS BAŞLIĞI / COLLET CHUCK	2-16 mm	42	100
312470.DGP	BBT 40 - 470 ER 32 PENS BAŞLIĞI / COLLET CHUCK	2-20 mm	50	100
312472.DGP	BBT 40 - 472 ER 40 PENS BAŞLIĞI / COLLET CHUCK	2-26 mm	63	100
316426.DGP	BBT 50 - 426 ER 16 PENS BAŞLIĞI / COLLET CHUCK	2-10 mm	32	100
316430.DGP	BBT 50 - 430 ER 25 PENS BAŞLIĞI / COLLET CHUCK	2-16 mm	42	100
316470.DGP	BBT 50 - 470 ER 32 PENS BAŞLIĞI / COLLET CHUCK	2-20 mm	50	100
316472.DGP	BBT 50 - 472 ER 40 PENS BAŞLIĞI / COLLET CHUCK	2-26 mm	63	100
316472-1.DGP	BBT 50 - 472 ER 40 PENS BAŞLIĞI / COLLET CHUCK	2-26 mm	63	130



DEĞERLİ
www.degerlimakina.com

JIS B 6339 (MAS 403 BBT)

DIN 6499 ER SERİSİ PENS BAŞLIĞI

DIN 6499 ER SERIES COLLET CHUCK

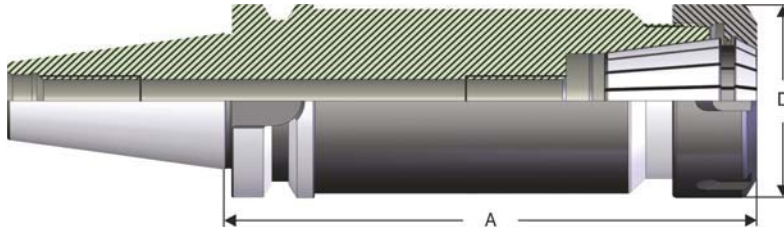

Sipariş Kodu Order Number	Ürün Adı Product Name	Kapasite Capacity	D	A
313426.DGP	BBT 40 - 426 ER 16 PENS BAŞLIĞI / COLLET CHUCK	2-10 mm	32	160
313426-1.DGP	BBT 40 - 426 ER 16 PENS BAŞLIĞI MİNİ / COLLET CHUCK	2-10 mm	22	160
313430.DGP	BBT 40 - 430 ER 25 PENS BAŞLIĞI / COLLET CHUCK	2-16 mm	42	160
313470.DGP	BBT 40 - 470 ER 32 PENS BAŞLIĞI / COLLET CHUCK	2-20 mm	50	160
313472.DGP	BBT 40 - 472 ER 40 PENS BAŞLIĞI / COLLET CHUCK	2-26 mm	63	160
317426.DGP	BBT 50 - 426 ER 16 PENS BAŞLIĞI / COLLET CHUCK	2-10 mm	32	160
317426-1.DGP	BBT 50 - 426 ER 16 PENS BAŞLIĞI MİNİ / COLLET CHUCK	2-10 mm	22	160
317426-2.DGP	BBT 50 - 426 ER 16 PENS BAŞLIĞI / COLLET CHUCK	2-10 mm	32	200
317430.DGP	BBT 50 - 430 ER 25 PENS BAŞLIĞI / COLLET CHUCK	2-16 mm	42	160
317470.DGP	BBT 50 - 470 ER 32 PENS BAŞLIĞI / COLLET CHUCK	2-20 mm	50	160
317472.DGP	BBT 50 - 472 ER 40 PENS BAŞLIĞI / COLLET CHUCK	2-26 mm	63	160
317472-1.DGP	BBT 50 - 472 ER 40 PENS BAŞLIĞI / COLLET CHUCK	2-26 mm	63	200

JIS B 6339 (MAS 403 BBT)

RULMANLI PENS BAŞLIĞI
PRECISION MILLING CHUCK

DEĞERLİ®
www.degerlimakina.com

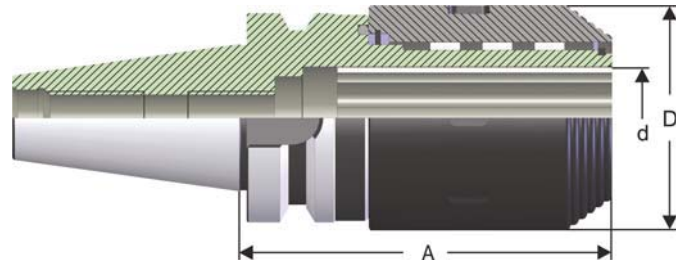

Sipariş Kodu Order Number	Ürün Adı Product Name	Kapasite Capacity (d)	A	D
318420.DGP	BBT 40 - RULMANLI PENS BAŞLIĞI / PRECISION MILLING CHUCK	6-20 mm	75	49
318432.DGP	BBT 40 - RULMANLI PENS BAŞLIĞI / PRECISION MILLING CHUCK	6-32 mm	90	68
319520.DGP	BBT 50 - RULMANLI PENS BAŞLIĞI / PRECISION MILLING CHUCK	6-20 mm	90	49
319532.DGP	BBT 50 - RULMANLI PENS BAŞLIĞI / PRECISION MILLING CHUCK	6-32 mm	95	68

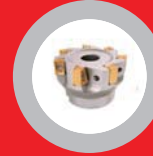
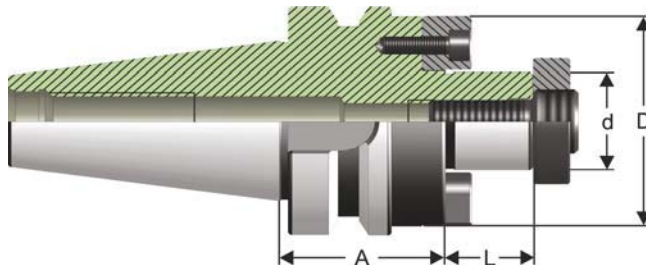

Sipariş Kodu Order Number	Ürün Adı Product Name	d h6	D	A	L
334016.DGP	BBT 40 - AT.B. 16 / SHELL MILL HOLDER	16	38	40	17
334022.DGP	BBT 40 - AT.B. 22 / SHELL MILL HOLDER	22	48	40	19
334027.DGP	BBT 40 - AT.B. 27 / SHELL MILL HOLDER	27	58	40	21
334032.DGP	BBT 40 - AT.B. 32 / SHELL MILL HOLDER	32	78	50	24
334040.DGP	BBT 40 - AT.B. 40 / SHELL MILL HOLDER	40	88	50	27
335016.DGP	BBT 50 - AT.B. 16 / SHELL MILL HOLDER	16	38	55	17
335022.DGP	BBT 50 - AT.B. 22 / SHELL MILL HOLDER	22	48	55	19
335027.DGP	BBT 50 - AT.B. 27 / SHELL MILL HOLDER	27	58	55	21
335032.DGP	BBT 50 - AT.B. 32 / SHELL MILL HOLDER	32	78	55	24
335040.DGP	BBT 50 - AT.B. 40 / SHELL MILL HOLDER	40	88	55	27
335060.DGP	BBT 50 - AT.B. 60 / SHELL MILL HOLDER	60	128	80	40

JIS B 6339 (MAS 403 BBT)
DIN 6357 ALIN KAMALI TARAMA TUTUCUSU
DIN 6357 SHELL MILL HOLDER

DEĞERLİ
www.degerlimakina.com

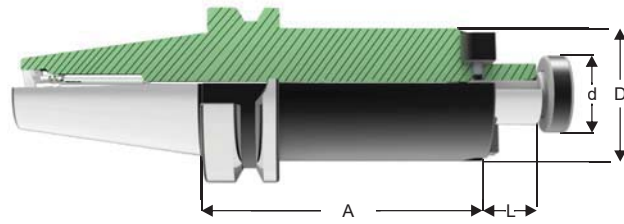

Sipariş Kodu Order Number	Ürün Adı Product Name	d h6	D	A	L
334116.DGP	BBT 40 - A.T.B. 16 / SHELL MILL HOLDER	16	38	100	17
334122.DGP	BBT 40 - A.T.B. 22 / SHELL MILL HOLDER	22	48	100	19
334127.DGP	BBT 40 - A.T.B. 27 / SHELL MILL HOLDER	27	58	100	21
334132.DGP	BBT 40 - A.T.B. 32 / SHELL MILL HOLDER	32	78	100	24
334140.DGP	BBT 40 - A.T.B. 40 / SHELL MILL HOLDER	40	88	100	27
335116.DGP	BBT 50 - A.T.B. 16 / SHELL MILL HOLDER	16	38	100	17
335122.DGP	BBT 50 - A.T.B. 22 / SHELL MILL HOLDER	22	48	100	19
335127.DGP	BBT 50 - A.T.B. 27 / SHELL MILL HOLDER	27	58	100	21
335132.DGP	BBT 50 - A.T.B. 32 / SHELL MILL HOLDER	32	78	100	24
335140.DGP	BBT 50 - A.T.B. 40 / SHELL MILL HOLDER	40	88	100	27



DEĞERLİ
www.degerlimakina.com

JIS B 6339 (MAS 403 BBT)

DIN 6357 ALIN KAMALI TARAMA TUTUCUSU

DIN 6357 SHELL MILL HOLDER

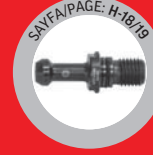
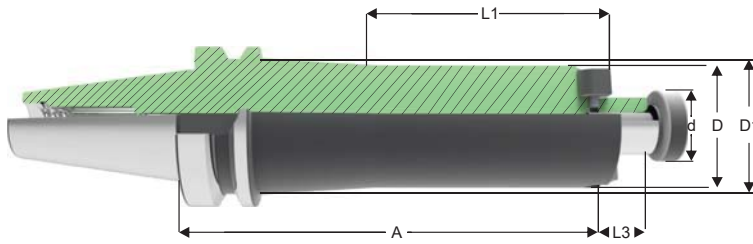

Sipariş Kodu Order Number	Ürün Adı Product Name	d h6	D	A	L1	L3	D1
334116.1.DGP	BBT 40 - A.T.B. 16 / SHELL MILL HOLDER	16	38	160	88	17	44,5
334122.1.DGP	BBT 40 - A.T.B. 22 / SHELL MILL HOLDER	22	48	160	-	19	-
334127.1.DGP	BBT 40 - A.T.B. 27 / SHELL MILL HOLDER	27	58	160	-	21	-
334132.1.DGP	BBT 40 - A.T.B. 32 / SHELL MILL HOLDER	32	78	160	-	24	-
334140.1.DGP	BBT 40 - A.T.B. 40 / SHELL MILL HOLDER	40	88	160	-	27	-
335116.1.DGP	BBT 50 - A.T.B. 16 / SHELL MILL HOLDER	16	38	130	-	17	-
335122.1.DGP	BBT 50 - A.T.B. 22 / SHELL MILL HOLDER	22	48	130	-	19	-
335127.1.DGP	BBT 50 - A.T.B. 27 / SHELL MILL HOLDER	27	58	130	-	21	-
335132.1.DGP	BBT 50 - A.T.B. 32 / SHELL MILL HOLDER	32	78	130	-	24	-
335140.1.DGP	BBT 50 - A.T.B. 40 / SHELL MILL HOLDER	40	88	130	-	27	-

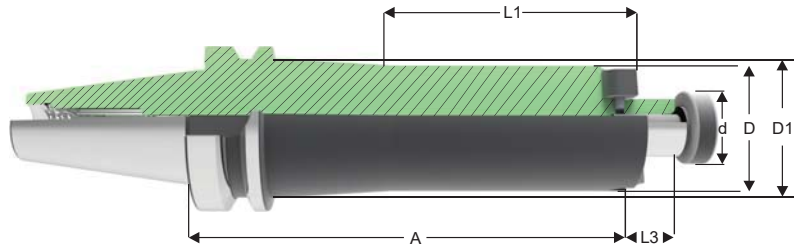

Sipariş Kodu Order Number	Ürün Adı Product Name	d h6	D	A	L1	L3	D1
335116.2.DGP	BBT 50 - A.T.B. 16 / SHELL MILL HOLDER	16	38	160	88	17	43
335122.2.DGP	BBT 50 - A.T.B. 22 / SHELL MILL HOLDER	22	48	160	88	19	53,5
335127.2.DGP	BBT 50 - A.T.B. 27 / SHELL MILL HOLDER	27	58	160	88	21	63,5
335132.2.DGP	BBT 50 - A.T.B. 32 / SHELL MILL HOLDER	32	78	160	-	24	-
335140.2.DGP	BBT 50 - A.T.B. 40 / SHELL MILL HOLDER	40	88	160	-	27	-
335116.3.DGP	BBT 50 - A.T.B. 16 / SHELL MILL HOLDER	16	38	200	88	17	47
335122.3.DGP	BBT 50 - A.T.B. 22 / SHELL MILL HOLDER	22	48	200	120	19	54,5
335127.3.DGP	BBT 50 - A.T.B. 27 / SHELL MILL HOLDER	27	58	200	120	21	64,5
335132.3.DGP	BBT 50 - A.T.B. 32 / SHELL MILL HOLDER	32	78	200	-	24	-
335140.3.DGP	BBT 50 - A.T.B. 40 / SHELL MILL HOLDER	40	88	200	-	27	-



DEĞERLİ
www.degerlimakina.com

JIS B 6339 (MAS 403 BBT)

BBT 40 DIN 6359 VELDON TUTUCU - DIN 1835-B

BBT 40 DIN 6359 END MILL HOLDER - DIN 1835-B

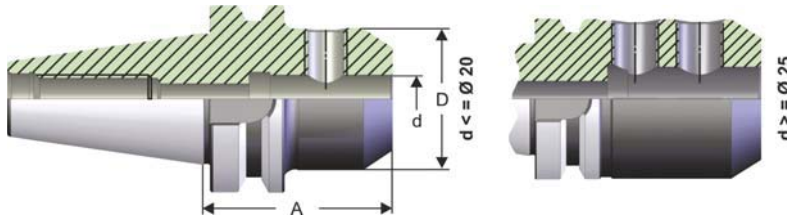

Sipariş Kodu Order Number	Ürün Adı Product Name	d h4	D	A
344006.DGP	BBT 40 VELDON / END MILL HOLDER	6	25	50
344008.DGP	BBT 40 VELDON / END MILL HOLDER	8	28	50
344010.DGP	BBT 40 VELDON / END MILL HOLDER	10	35	63
344012.DGP	BBT 40 VELDON / END MILL HOLDER	12	42	63
344014.DGP	BBT 40 VELDON / END MILL HOLDER	14	44	63
344016.DGP	BBT 40 VELDON / END MILL HOLDER	16	48	63
344016.0.DGP	BBT 40 VELDON / END MILL HOLDER	16	48	35
344018.DGP	BBT 40 VELDON / END MILL HOLDER	18	50	63
344020.DGP	BBT 40 VELDON / END MILL HOLDER	20	52	63
344020.0.DGP	BBT 40 VELDON / END MILL HOLDER	20	52	35
344025.DGP	BBT 40 VELDON / END MILL HOLDER	25	63	90
344025.0.DGP	BBT 40 VELDON / END MILL HOLDER	25	63	35
344032.DGP	BBT 40 VELDON / END MILL HOLDER	32	72	100
344032.0.DGP	BBT 40 VELDON / END MILL HOLDER	32	72	65
344040.DGP	BBT 40 VELDON / END MILL HOLDER	40	79	120

JIS B 6339 (MAS 403 BBT)

BBT 40 DIN 6359 VELDON TUTUCU - DIN 1835-B
BBT 40 DIN 6359 END MILL HOLDER - DIN 1835-B

DEĞERLİ
www.degerlimakina.com

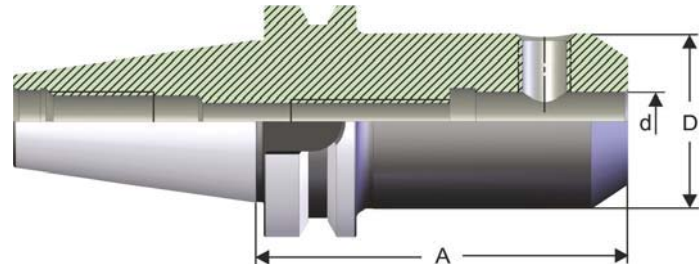

Sipariş Kodu Order Number	Ürün Adı Product Name	d h4	D	A
344106.DGP	BBT 40 VELDON / END MILL HOLDER	6	25	100
344108.DGP	BBT 40 VELDON / END MILL HOLDER	8	28	100
344110.DGP	BBT 40 VELDON / END MILL HOLDER	10	35	100
344112.DGP	BBT 40 VELDON / END MILL HOLDER	12	42	100
344114.DGP	BBT 40 VELDON / END MILL HOLDER	14	44	100
344116.DGP	BBT 40 VELDON / END MILL HOLDER	16	48	100
344118.DGP	BBT 40 VELDON / END MILL HOLDER	18	50	100
344120.DGP	BBT 40 VELDON / END MILL HOLDER	20	52	100



DEĞERLİ
www.degerlimakina.com

JIS B 6339 (MAS 403 BBT)

BBT 50 DIN 6359 VELDON TUTUCU - DIN 1835-B

BBT 50 DIN 6359 END MILL HOLDER - DIN 1835-B

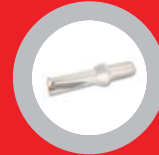
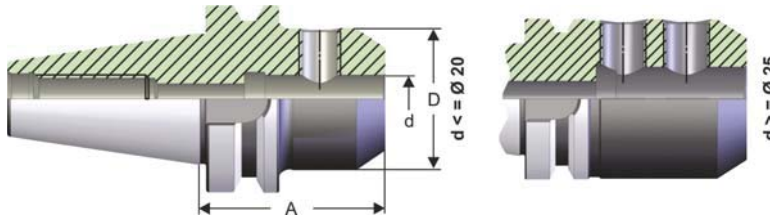

Sipariş Kodu Order Number	Ürün Adı Product Name	d h4	D	A
345006.DGP	BBT 50 VELDON / END MILL HOLDER	6	25	63
345008.DGP	BBT 50 VELDON / END MILL HOLDER	8	28	63
345010.DGP	BBT 50 VELDON / END MILL HOLDER	10	35	63
345012.DGP	BBT 50 VELDON / END MILL HOLDER	12	42	80
345014.DGP	BBT 50 VELDON / END MILL HOLDER	14	44	80
345016.DGP	BBT 50 VELDON / END MILL HOLDER	16	48	80
345018.DGP	BBT 50 VELDON / END MILL HOLDER	18	50	80
345020.DGP	BBT 50 VELDON / END MILL HOLDER	20	52	80
345025.DGP	BBT 50 VELDON / END MILL HOLDER	25	65	100
345032.DGP	BBT 50 VELDON / END MILL HOLDER	32	72	105
345040.DGP	BBT 50 VELDON / END MILL HOLDER	40	80	110

JIS B 6339 (MAS 403 BBT)

BBT 50 DIN 6359 VELDON TUTUCU - DIN 1835-B
BBT 50 DIN 6359 END MILL HOLDER - DIN 1835-B

DEĞERLİ®
www.degerlimakina.com

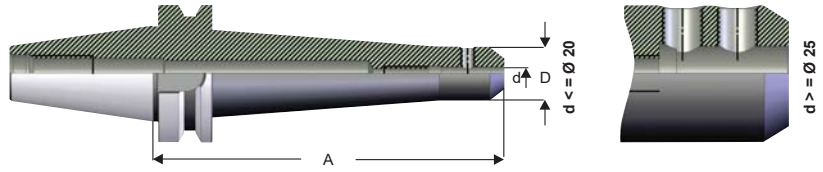

Sipariş Kodu Order Number	Ürün Adı Product Name	d h4	D	A
345106.DGP	BBT 50 VELDON / END MILL HOLDER	6	25	160
345108.DGP	BBT 50 VELDON / END MILL HOLDER	8	28	160
345110.DGP	BBT 50 VELDON / END MILL HOLDER	10	35	160
345112.DGP	BBT 50 VELDON / END MILL HOLDER	12	42	160
345114.DGP	BBT 50 VELDON / END MILL HOLDER	14	44	160
345116.DGP	BBT 50 VELDON / END MILL HOLDER	16	48	160
345118.DGP	BBT 50 VELDON / END MILL HOLDER	18	50	160
345120.DGP	BBT 50 VELDON / END MILL HOLDER	20	52	160
345125.DGP	BBT 50 VELDON / END MILL HOLDER	25	65	160
345132.DGP	BBT 50 VELDON / END MILL HOLDER	32	72	160
345140.DGP	BBT 50 VELDON / END MILL HOLDER	40	80	160



DEĞERLİ
www.degerlimakina.com

JIS B 6339 (MAS 403 BBT)

VİDALI FREZE TAKIM TUTUCULARI

SET HOLDERS FOR SCREW MILLING CUTTERS

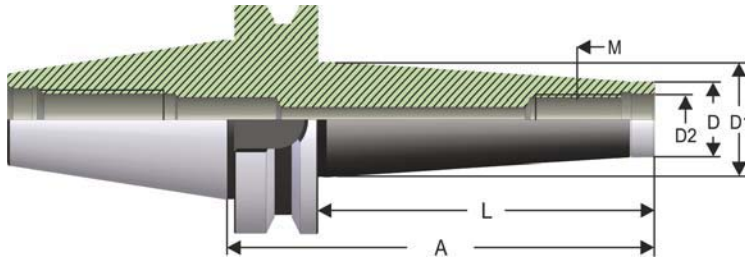

Sipariş Kodu Order Number	M	D	D1	A	L	D2
384006.DGP	M6	10	13	52	25	6,5
384006.1.DGP	M6	10	20	77	50	6,5
384006.2.DGP	M6	10	23	102	75	6,5
384008.DGP	M8	13	15	52	25	8,5
384008.1.DGP	M8	13	23	77	50	8,5
384008.2.DGP	M8	13	23	102	75	8,5
384008.3.DGP	M8	13	25	127	100	8,5
384010.DGP	M10	18	20	52	25	10,5
384010.1.DGP	M10	18	23	77	50	10,5
384010.2.DGP	M10	18	28	102	75	10,5
384010.3.DGP	M10	18	36,5	177	150	10,5
384012.DGP	M12	21	24	52	25	12,5
384012.1.DGP	M12	21	24	77	50	12,5
384012.2.DGP	M12	21	31	102	75	12,5
384012.3.DGP	M12	21	36	152	125	12,5
384012.4.DGP	M12	21	38	177	150	12,5
384016.DGP	M16	29	29	52	25	17
384016.1.DGP	M16	29	34	77	50	17
384016.2.DGP	M16	29	34	102	75	17
384016.3.DGP	M16	29	36	127	100	17
384016.4.DGP	M16	29	40	152	125	17
384016.5.DGP	M16	29	42,5	177	150	17

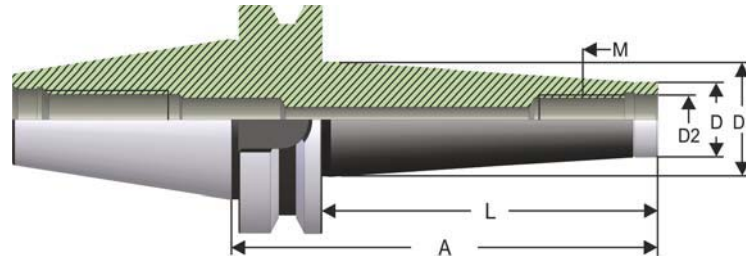
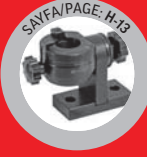

Sipariş Kodu Order Number	M	D	D1	A	L	D2
385008.DGP	M8	13	23	88	50	8,5
385008.1.DGP	M8	13	25	138	100	8,5
385008.2.DGP	M8	13	30	188	150	8,5
385010.DGP	M10	18	23	88	50	10,5
385010.1.DGP	M10	18	32	138	100	10,5
385010.2.DGP	M10	18	36,5	188	150	10,5
385012.DGP	M12	21	24	88	50	12,5
385012.1.DGP	M12	21	33	138	100	12,5
385012.2.DGP	M12	21	40	188	150	12,5
385016.DGP	M16	29	34	88	50	16,5
385016.1.DGP	M16	29	36	138	100	16,5
385016.2.DGP	M16	29	42,5	188	150	16,5



DEĞERLİ
www.degerlimakina.com

JIS B 6339 (MAS 403 BBT)

DIN 6499 / ER SERİSİ TAKIMLAR

DIN 6499 / COLLET SET IN BOX ER SERIES



Sipariş Kodu Order Number	Ürün Adı Product Name	Adet Piece	Ölçüler Contents
394430.DGP	BBT 40 - 430 PENS TAKIMI 430 COLLET SET İN BOX	14	3-4-5-6-7-8-9-10-11-12-14-16 - 9042430 - 311430.DGP
394470.DGP	BBT 40 - 470 PENS TAKIMI 470 COLLET SET İN BOX	16	3-4-5-6-7-8-9-10-11-12-14-16-18-20 - 9050470 - 311470.DGP
394472.DGP	BBT 40 - 472 PENS TAKIMI 472 COLLET SET İN BOX	18	4-5-6-7-8-9-10-11-12-14-16-18-20-22-24-26 - 9063472 - 311472.DGP
395470.DGP	BBT 50 - 470 PENS TAKIMI 470 COLLET SET İN BOX	16	3-4-5-6-7-8-9-10-11-12-14-16-18-20 - 9050470 - 315470.DGP
395472.DGP	BBT 50 - 472 PENS TAKIMI 472 COLLET SET İN BOX	18	4-5-6-7-8-9-10-11-12-14-16-18-20-22-24-26 - 9063472 - 315472.DGP

JIS B 6339 (MAS 403 BBT)
RULMANLI PENS TAKIMI
PRECISION MILLING CHUCK SET IN BOX

DEĞERLİ
www.degerlimakina.com



Sipariş Kodu Order Number	Ürün Adı Product Name	Adet Piece	Ölçüler Contents
398420.DGP	BBT 40 RULMANLI PENS TAKIMI PRECISION MILLING CHUCK SET IN BOX	7	6-8-10-12-16 - 904550 - 318420.DGP
398432.DGP	BBT 40 RULMANLI PENS TAKIMI PRECISION MILLING CHUCK SET IN BOX	9	6-8-10-12-16-20-25 -906875 - 318432.DGP
399520.DGP	BBT 50 RULMANLI PENS TAKIMI PRECISION MILLING CHUCK SET IN BOX	7	6-8-10-12-16 - 904550 - 319520.DGP
399532.DGP	BBT 50 RULMANLI PENS TAKIMI PRECISION MILLING CHUCK SET IN BOX	9	6-8-10-12-16-20-25 -906875 - 319532.DGP

**SİLİNDİRİK ŞAFTLI
TUTUCULAR**
CYRINDIRICAL SHAFT
TOOLHOLDERS



SSPB 251ER25170 PB
(430) TM 09 17 26

VIR

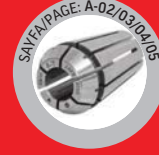
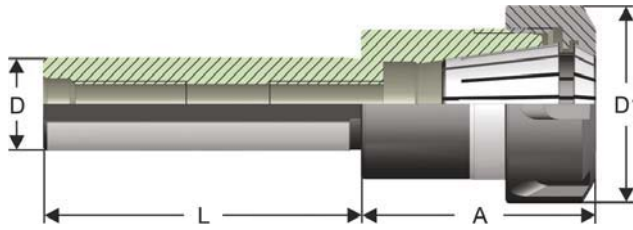

Sipariş Kodu Order Number	Ürün Adı Product Name	Kapasite Capacity	D	L	A	D1
416426.3	SİL.ŞAFTLI ER 16 - 426 MİNİ / SHAFT Ø 16 COLLET CHUCKS	2-10 mm	16	150	35	22
420426	SİL.ŞAFTLI ER 16 - 426 / SHAFT Ø 20 COLLET CHUCKS	2-10 mm	20	70	30	32
420426.1	SİL.ŞAFTLI ER 16 - 426 / SHAFT Ø 20 COLLET CHUCKS	2-10 mm	20	100	30	32
420426.2	SİL.ŞAFTLI ER 16 - 426 MİNİ / SHAFT Ø 20 COLLET CHUCKS	2-10 mm	20	100	30	22
420426.3	SİL.ŞAFTLI ER 16 - 426 MİNİ / SHAFT Ø 20 COLLET CHUCKS	2-10 mm	20	150	30	22
420426.4	SİL.ŞAFTLI ER 16 - 426 / SHAFT Ø 20 COLLET CHUCKS	2-10 mm	20	150	30	32
420426.5	SİL.ŞAFTLI ER 16 - 426 MİNİ / SHAFT Ø 20 COLLET CHUCKS	2-10 mm	20	200	30	22
420428	SİL.ŞAFTLI ER 20 - 428 / SHAFT Ø 20 COLLET CHUCKS	2-13 mm	20	70	45	34
420428.1	SİL.ŞAFTLI ER 20 - 428 / SHAFT Ø 20 COLLET CHUCKS	2-13 mm	20	100	45	34
420428.2	SİL.ŞAFTLI ER 20 - 428 / SHAFT Ø 20 COLLET CHUCKS	2-13 mm	20	150	45	34
420430	SİL.ŞAFTLI ER 25 - 430 / SHAFT Ø 20 COLLET CHUCKS	2-16 mm	20	70	52	42
420430.1	SİL.ŞAFTLI ER 25 - 430 / SHAFT Ø 20 COLLET CHUCKS	2-16 mm	20	150	52	42
420470	SİL.ŞAFTLI ER 32 - 470 / SHAFT Ø 20 COLLET CHUCKS	2-20 mm	20	70	55	50
420470.1	SİL.ŞAFTLI ER 32 - 470 / SHAFT Ø 20 COLLET CHUCKS	2-20 mm	20	150	55	50

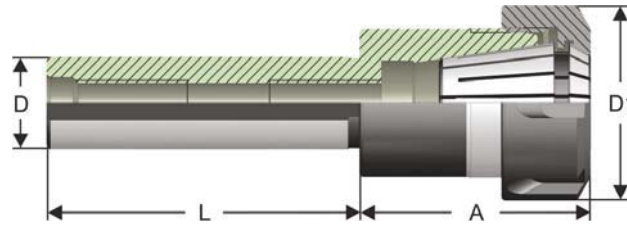

Sipariş Kodu Order Number	Ürün Adı Product Name	Kapasite Capacity	D	L	A	D1
425426	SİL.ŞAFTLI ER 16 - 426 / SHAFT Ø 25 COLLET CHUCKS	2-10 mm	25	70	32	32
425426.1	SİL.ŞAFTLI ER 16 - 426 / SHAFT Ø 25 COLLET CHUCKS	2-10 mm	25	150	32	32
425428	SİL.ŞAFTLI ER 20 - 428 / SHAFT Ø 25 COLLET CHUCKS	2-13 mm	25	70	35	34
425428.1	SİL.ŞAFTLI ER 20 - 428 / SHAFT Ø 25 COLLET CHUCKS	2-13 mm	25	150	35	34
425430	SİL.ŞAFTLI ER 25 - 430 / SHAFT Ø 25 COLLET CHUCKS	2-16 mm	25	70	50	42
425430.1	SİL.ŞAFTLI ER 25 - 430 / SHAFT Ø 25 COLLET CHUCKS	2-16 mm	25	150	50	42
425470	SİL.ŞAFTLI ER 32 - 470 / SHAFT Ø 25 COLLET CHUCKS	2-20 mm	25	70	55	50
425470.1	SİL.ŞAFTLI ER 32 - 470 / SHAFT Ø 25 COLLET CHUCKS	2-20 mm	25	150	55	50

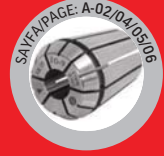
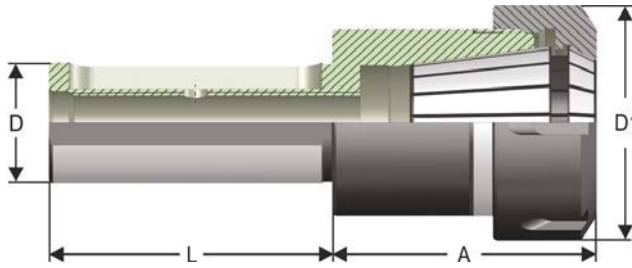

Sipariş Kodu Order Number	Ürün Adı Product Name	Kapasite Capacity	D	L	A	D1
432426	SİL.ŞAFTLI ER 16 - 426 / SHAFT Ø 32 COLLET CHUCKS	2-10 mm	32	80	32	32
432430	SİL.ŞAFTLI ER 25 - 430 / SHAFT Ø 32 COLLET CHUCKS	2-16 mm	32	80	32	42
432430.1	SİL.ŞAFTLI ER 25 - 430 / SHAFT Ø 32 COLLET CHUCKS	2-16 mm	32	150	32	42
432470	SİL.ŞAFTLI ER 32 - 470 / SHAFT Ø 32 COLLET CHUCKS	2-20 mm	32	80	52	50
432470.1	SİL.ŞAFTLI ER 32 - 470 / SHAFT Ø 32 COLLET CHUCKS	2-20 mm	32	150	52	50
432472	SİL.ŞAFTLI ER 40 - 472 / SHAFT Ø 32 COLLET CHUCKS	2-26 mm	32	80	63	63
432472.1	SİL.ŞAFTLI ER 40 - 472 / SHAFT Ø 32 COLLET CHUCKS	2-26 mm	32	150	63	63

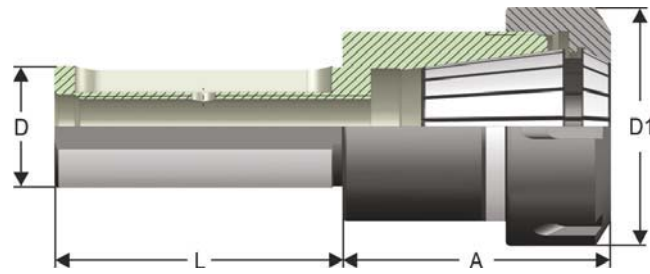
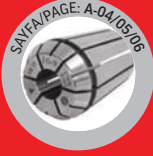

Sipariş Kodu Order Number	Ürün Adı Product Name	Kapasite Capacity	D	L	A	D1
440430	SİL.ŞAFTLI ER 25 - 430 / SHAFT Ø 40 COLLET CHUCKS	2-16 mm	40	85	32	42
440430.1	SİL.ŞAFTLI ER 25 - 430 / SHAFT Ø 40 COLLET CHUCKS	2-16 mm	40	150	32	42
440470	SİL.ŞAFTLI ER 32 - 470 / SHAFT Ø 40 COLLET CHUCKS	2-20 mm	40	85	35	50
440470.1	SİL.ŞAFTLI ER 32 - 470 / SHAFT Ø 40 COLLET CHUCKS	2-20 mm	40	150	35	50
440472	SİL.ŞAFTLI ER 40 - 472 / SHAFT Ø 40 COLLET CHUCKS	2-26 mm	40	85	45	63
440472.1	SİL.ŞAFTLI ER 40 - 472 / SHAFT Ø 40 COLLET CHUCKS	2-26 mm	40	150	45	63



DEĞERLİ
www.degerlimakina.com

Ø 20 SİLİNDİRİK ŞAFTLI REDÜKSİYON KOVANI

Ø 20 REDUCTION BUSHES FOR BORING BAR HOLDER

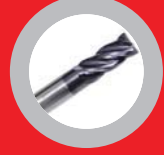
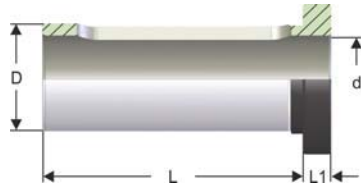

Sipariş Kodu Order Number	Ürün Adı Product Name	d	D	L	L1
42006	SİLİNDİRİK ŞAFTLI REDÜKSİYON KOVANI / SHAFT Ø 20 REDUCTION HOLDER	6	20	40	5
42008	SİLİNDİRİK ŞAFTLI REDÜKSİYON KOVANI / SHAFT Ø 20 REDUCTION HOLDER	8	20	40	5
42010	SİLİNDİRİK ŞAFTLI REDÜKSİYON KOVANI / SHAFT Ø 20 REDUCTION HOLDER	10	20	40	5
42012	SİLİNDİRİK ŞAFTLI REDÜKSİYON KOVANI / SHAFT Ø 20 REDUCTION HOLDER	12	20	40	5
42014	SİLİNDİRİK ŞAFTLI REDÜKSİYON KOVANI / SHAFT Ø 20 REDUCTION HOLDER	14	20	40	5
42016	SİLİNDİRİK ŞAFTLI REDÜKSİYON KOVANI / SHAFT Ø 20 REDUCTION HOLDER	16	20	40	5

Ø 25 SİLİNDİRİK ŞAFTLI REDÜKSİYON KOVANI
Ø 25 REDUCTION BUSHES FOR BORING BAR HOLDER

DEĞERLİ®
www.degerlimakina.com

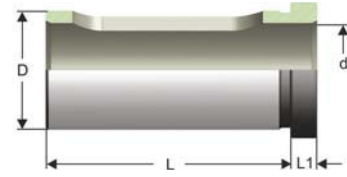
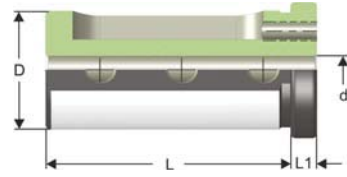
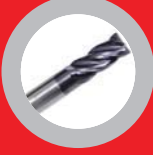

Sipariş Kodu Order Number	Ürün Adı Product Name	d	D	L	L1
42506	SİLİNDİRİK ŞAFTLI REDÜKSİYON KOVANI / SHAFT Ø 25 REDUCTION HOLDER	6	25	45	5
42508	SİLİNDİRİK ŞAFTLI REDÜKSİYON KOVANI / SHAFT Ø 25 REDUCTION HOLDER	8	25	45	5
42510	SİLİNDİRİK ŞAFTLI REDÜKSİYON KOVANI / SHAFT Ø 25 REDUCTION HOLDER	10	25	45	5
42512	SİLİNDİRİK ŞAFTLI REDÜKSİYON KOVANI / SHAFT Ø 25 REDUCTION HOLDER	12	25	45	5
42514	SİLİNDİRİK ŞAFTLI REDÜKSİYON KOVANI / SHAFT Ø 25 REDUCTION HOLDER	14	25	45	5
42516	SİLİNDİRİK ŞAFTLI REDÜKSİYON KOVANI / SHAFT Ø 25 REDUCTION HOLDER	16	25	45	5
42520	SİLİNDİRİK ŞAFTLI REDÜKSİYON KOVANI / SHAFT Ø 25 REDUCTION HOLDER	20	25	45	5



DEĞERLİ
www.degerlimakina.com

Ø 32 SİLİNDİRİK ŞAFTLI REDÜKSİYON KOVANI

Ø 32 REDUCTION BUSHES FOR BORING BAR HOLDER

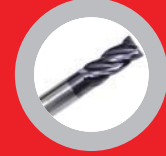
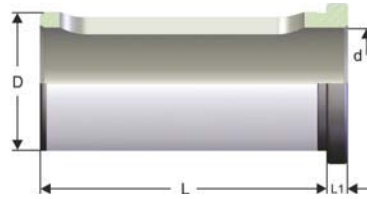
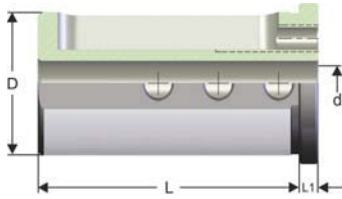

Sipariş Kodu Order Number	Ürün Adı Product Name	d	D	L	L1
43206	SİLİNDİRİK ŞAFTLI REDÜKSİYON KOVANI / SHAFT Ø 32 REDUCTION HOLDER	6	32	65	5
43208	SİLİNDİRİK ŞAFTLI REDÜKSİYON KOVANI / SHAFT Ø 32 REDUCTION HOLDER	8	32	65	5
43210	SİLİNDİRİK ŞAFTLI REDÜKSİYON KOVANI / SHAFT Ø 32 REDUCTION HOLDER	10	32	65	5
43212	SİLİNDİRİK ŞAFTLI REDÜKSİYON KOVANI / SHAFT Ø 32 REDUCTION HOLDER	12	32	65	5
43214	SİLİNDİRİK ŞAFTLI REDÜKSİYON KOVANI / SHAFT Ø 32 REDUCTION HOLDER	14	32	65	5
43216	SİLİNDİRİK ŞAFTLI REDÜKSİYON KOVANI / SHAFT Ø 32 REDUCTION HOLDER	16	32	65	5
43220	SİLİNDİRİK ŞAFTLI REDÜKSİYON KOVANI / SHAFT Ø 32 REDUCTION HOLDER	20	32	65	5
43225	SİLİNDİRİK ŞAFTLI REDÜKSİYON KOVANI / SHAFT Ø 32 REDUCTION HOLDER	25	32	65	5

Ø 40 SİLİNDİRİK ŞAFTLI REDÜKSİYON KOVANI
Ø 40 REDUCTION BUSHES FOR BORING BAR HOLDER

DEĞERLİ®
www.degerlimakina.com

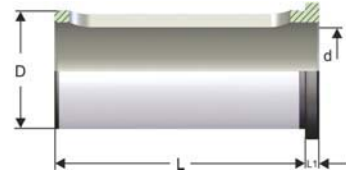
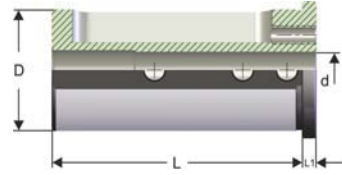

Sipariş Kodu Order Number	Ürün Adı Product Name	d	D	L	L1
44006	SİLİNDİRİK ŞAFTLI REDÜKSİYON KOVANI / SHAFT Ø 40 REDUCTION HOLDER	6	40	75	5
44008	SİLİNDİRİK ŞAFTLI REDÜKSİYON KOVANI / SHAFT Ø 40 REDUCTION HOLDER	8	40	75	5
44010	SİLİNDİRİK ŞAFTLI REDÜKSİYON KOVANI / SHAFT Ø 40 REDUCTION HOLDER	10	40	75	5
44012	SİLİNDİRİK ŞAFTLI REDÜKSİYON KOVANI / SHAFT Ø 40 REDUCTION HOLDER	12	40	75	5
44014	SİLİNDİRİK ŞAFTLI REDÜKSİYON KOVANI / SHAFT Ø 40 REDUCTION HOLDER	14	40	75	5
44016	SİLİNDİRİK ŞAFTLI REDÜKSİYON KOVANI / SHAFT Ø 40 REDUCTION HOLDER	16	40	75	5
44020	SİLİNDİRİK ŞAFTLI REDÜKSİYON KOVANI / SHAFT Ø 40 REDUCTION HOLDER	20	40	75	5
44025	SİLİNDİRİK ŞAFTLI REDÜKSİYON KOVANI / SHAFT Ø 40 REDUCTION HOLDER	25	40	75	5
44032	SİLİNDİRİK ŞAFTLI REDÜKSİYON KOVANI / SHAFT Ø 40 REDUCTION HOLDER	32	40	75	5

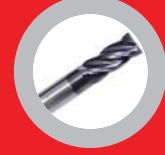
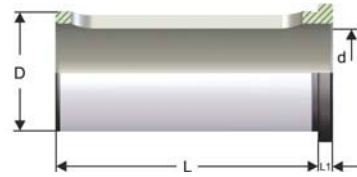
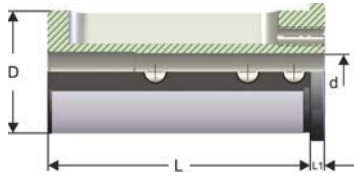

Sipariş Kodu Order Number	Ürün Adı Product Name	d	D	L	L1
45006	SİLİNDİRİK ŞAFTLI REDÜKSİYON KOVANI / SHAFT Ø 50 REDUCTION HOLDER	6	50	90	5
45008	SİLİNDİRİK ŞAFTLI REDÜKSİYON KOVANI / SHAFT Ø 50 REDUCTION HOLDER	8	50	90	5
45010	SİLİNDİRİK ŞAFTLI REDÜKSİYON KOVANI / SHAFT Ø 50 REDUCTION HOLDER	10	50	90	5
45012	SİLİNDİRİK ŞAFTLI REDÜKSİYON KOVANI / SHAFT Ø 50 REDUCTION HOLDER	12	50	90	5
45014	SİLİNDİRİK ŞAFTLI REDÜKSİYON KOVANI / SHAFT Ø 50 REDUCTION HOLDER	14	50	90	5
45016	SİLİNDİRİK ŞAFTLI REDÜKSİYON KOVANI / SHAFT Ø 50 REDUCTION HOLDER	16	50	90	5
45020	SİLİNDİRİK ŞAFTLI REDÜKSİYON KOVANI / SHAFT Ø 50 REDUCTION HOLDER	20	50	90	5
45025	SİLİNDİRİK ŞAFTLI REDÜKSİYON KOVANI / SHAFT Ø 50 REDUCTION HOLDER	25	50	90	5
45032	SİLİNDİRİK ŞAFTLI REDÜKSİYON KOVANI / SHAFT Ø 50 REDUCTION HOLDER	32	50	90	5
45040	SİLİNDİRİK ŞAFTLI REDÜKSİYON KOVANI / SHAFT Ø 50 REDUCTION HOLDER	40	50	90	5

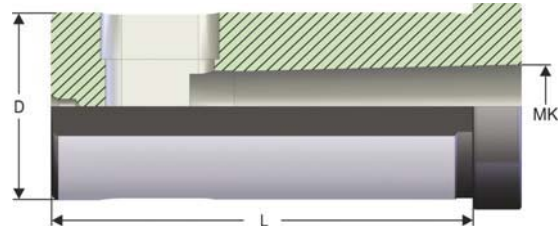

Sipariş Kodu Order Number	Ürün Adı Product Name	Mk Morse	D	L
43201	SİLİNDİRİK ŞAFTLI MORS ADAPTÖRÜ / TOOLHOLDER MORSE ADAPTOR	1	32	75
43202	SİLİNDİRİK ŞAFTLI MORS ADAPTÖRÜ / TOOLHOLDER MORSE ADAPTOR	2	32	80
43203	SİLİNDİRİK ŞAFTLI MORS ADAPTÖRÜ / TOOLHOLDER MORSE ADAPTOR	3	32	80
44001	SİLİNDİRİK ŞAFTLI MORS ADAPTÖRÜ / TOOLHOLDER MORSE ADAPTOR	1	40	75
44002	SİLİNDİRİK ŞAFTLI MORS ADAPTÖRÜ / TOOLHOLDER MORSE ADAPTOR	2	40	85
44003	SİLİNDİRİK ŞAFTLI MORS ADAPTÖRÜ / TOOLHOLDER MORSE ADAPTOR	3	40	85
44004	SİLİNDİRİK ŞAFTLI MORS ADAPTÖRÜ / TOOLHOLDER MORSE ADAPTOR	4	40	85
45001	SİLİNDİRİK ŞAFTLI MORS ADAPTÖRÜ / TOOLHOLDER MORSE ADAPTOR	1	50	75
45002	SİLİNDİRİK ŞAFTLI MORS ADAPTÖRÜ / TOOLHOLDER MORSE ADAPTOR	2	50	88
45003	SİLİNDİRİK ŞAFTLI MORS ADAPTÖRÜ / TOOLHOLDER MORSE ADAPTOR	3	50	90
45004	SİLİNDİRİK ŞAFTLI MORS ADAPTÖRÜ / TOOLHOLDER MORSE ADAPTOR	4	50	90

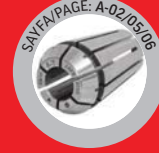
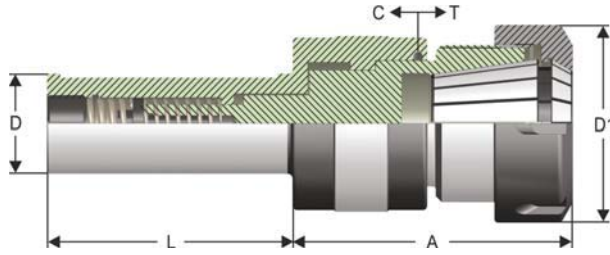

Sipariş Kodu Order Number	Kapasite Capacity	D	L	A	D1	C	T
4820426	2-10 mm	20	80	42	32	8	3
4825426	2-10 mm	25	80	42	32	8	3
4832470	2-20 mm	32	80	77	50	9	4
4832472	2-26 mm	32	80	96	63	9	4

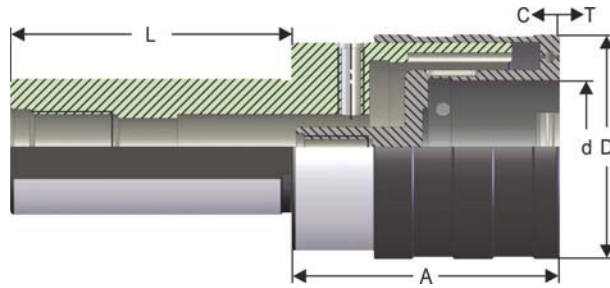

Sipariş Kodu Order Number	Ürün Adı Product Name	Kapasite Capacity	A	D	d	C	T	L
4825214	SİL.ŞAFTLI EM.TİP KLAVUZ ÇEKME / QUICK-CHANGE TAPPING CHUCKS	M2-M14	45	38	19	7	7	70
4825524	SİL.ŞAFTLI EM.TİP KLAVUZ ÇEKME / QUICK-CHANGE TAPPING CHUCKS	M5-M24	71	54	31	12	12	70
4832214	SİL.ŞAFTLI EM.TİP KLAVUZ ÇEKME / QUICK-CHANGE TAPPING CHUCKS	M2-M14	45	38	19	7	7	80
4832524	SİL.ŞAFTLI EM.TİP KLAVUZ ÇEKME / QUICK-CHANGE TAPPING CHUCKS	M5-M24	71	54	31	12	12	80
4840214	SİL.ŞAFTLI EM.TİP KLAVUZ ÇEKME / QUICK-CHANGE TAPPING CHUCKS	M2-M14	45	38	19	7	7	85
4840524	SİL.ŞAFTLI EM.TİP KLAVUZ ÇEKME / QUICK-CHANGE TAPPING CHUCKS	M5-M24	71	54	31	12	12	85
4850524	SİL.ŞAFTLI EM.TİP KLAVUZ ÇEKME / QUICK-CHANGE TAPPING CHUCKS	M5-M24	71	54	31	12	12	100



Sipariş Kodu Order Number	Ürün Adı Product Name	Adet Piece	Ölçüler Contents
4920430	Ø 20 - 430 PENS TAKIMI 430 COLLET SET İN BOX	14	3-4-5-6-7-8-9-10-11-12-14-16 - 9042430 - 420430
4920470	Ø 20 - 470 PENS TAKIMI 470 COLLET SET İN BOX	16	3-4-5-6-7-8-9-10-11-12-14-16-18-20 - 9050470 - 420470
4925430	Ø 25 - 430 PENS TAKIMI 430 COLLET SET İN BOX	14	3-4-5-6-7-8-9-10-11-12-14-16 - 9042430 - 425430
4925470	Ø 25 - 470 PENS TAKIMI 470 COLLET SET İN BOX	16	3-4-5-6-7-8-9-10-11-12-14-16-18-20 - 9050470 - 425470
4932430	Ø 32 - 430 PENS TAKIMI 430 COLLET SET İN BOX	14	3-4-5-6-7-8-9-10-11-12-14-16 - 9042430 - 432430
4932470	Ø 32 - 470 PENS TAKIMI 470 COLLET SET İN BOX	16	3-4-5-6-7-8-9-10-11-12-14-16-18-20 - 9050470 - 432470
4932472	Ø 32 - 472 PENS TAKIMI 472 COLLET SET İN BOX	18	4-5-6-7-8-9-10-11-12-14-16-18-20-22-24-26 - 9063472 - 432472
4940430	Ø 40 - 430 PENS TAKIMI 430 COLLET SET İN BOX	14	3-4-5-6-7-8-9-10-11-12-14-16 - 9042430 - 440430
4940470	Ø 40 - 470 PENS TAKIMI 470 COLLET SET İN BOX	16	3-4-5-6-7-8-9-10-11-12-14-16-18-20 - 9050470 - 440470
4940472	Ø 40 - 472 PENS TAKIMI 472 COLLET SET İN BOX	18	4-5-6-7-8-9-10-11-12-14-16-18-20-22-24-26 - 9063472 - 440472



DIN 69871 AD
SK TUTUCULAR
SK TOOLHOLDERS



DEĞERLİ
www.degerlimakina.com

DIN 69871 AD

SK ŞAFT ÖLÇÜLERİ

SK TOOLHOLDERS NORM

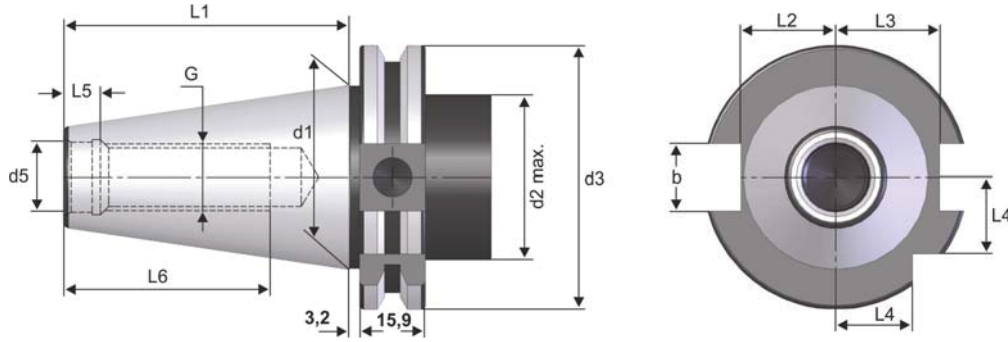

STANDART
BALANS
G 6,3
15000 min⁻¹



Ürün Adı Product Name	d1	G	d5	d2	d3	L1	L2	L3	L4	L5	L6	b
SK 30	31,75	M12	13	45	50,00	47,80	16,4	19,0	15	5,5	24	16,1
SK 40	44,45	M16	17	50	63,55	68,40	22,8	25,0	18,5	8,2	32	16,1
SK 50	69,85	M24	25	80	97,50	101,75	35,5	37,7	30	11,5	47	25,7

DIN 69871 AD

DIN 6391 PENS BAŞLIĞI DIN 6388 PENS

DIN 6391 COLLET CHUCK DIN 6388 COLLET

DEĞERLİ®

www.degerlimakina.com

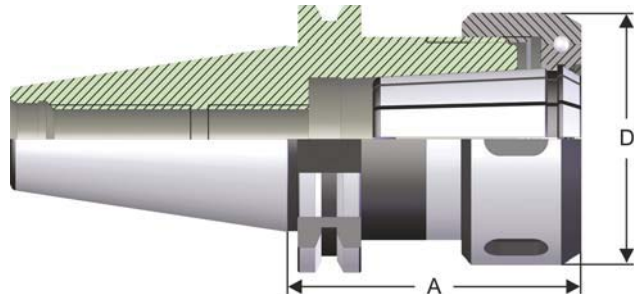

Sipariş Kodu Order Number	Ürün Adı Product Name	Kapasite Capacity (d)	D	A
510415	SK 30 - 415 PENS BAŞLIĞI / COLLET CHUCK	2-16 mm	43	60
510462	SK 30 - 462 PENS BAŞLIĞI / COLLET CHUCK	2-25 mm	60	80
511415	SK 40 - 415 PENS BAŞLIĞI / COLLET CHUCK	2-16 mm	43	70
511462	SK 40 - 462 PENS BAŞLIĞI / COLLET CHUCK	2-25 mm	60	70
511467	SK 40 - 467 PENS BAŞLIĞI / COLLET CHUCK	3-32 mm	72	90
515462	SK 50 - 462 PENS BAŞLIĞI / COLLET CHUCK	2-25 mm	60	70
515467	SK 50 - 467 PENS BAŞLIĞI / COLLET CHUCK	3-32 mm	72	80
515468	SK 50 - 468 PENS BAŞLIĞI / COLLET CHUCK	3-40 mm	85	95



DEĞERLİ
www.degerlimakina.com

DIN 69871 AD

DIN 6499 ER SERİSİ PENS BAŞLIĞI

DIN 6499 ER SERIES COLLET CHUCK

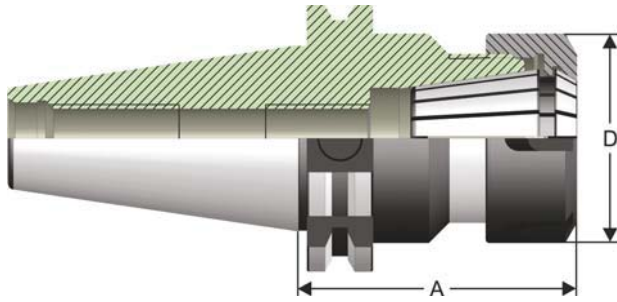

Sipariş Kodu Order Number	Ürün Adı Product Name	Kapasite Capacity (d)	D	A
510426	SK 30 - 426 ER 16 PENS BAŞLIĞI / COLLET CHUCK	2-10 mm	32	70
510430	SK 30 - 430 ER 25 PENS BAŞLIĞI / COLLET CHUCK	2-16 mm	42	70
510470	SK 30 - 470 ER 32 PENS BAŞLIĞI / COLLET CHUCK	2-20 mm	50	70
510472	SK 30 - 472 ER 40 PENS BAŞLIĞI / COLLET CHUCK	2-26 mm	63	70
511426	SK 40 - 426 ER 16 PENS BAŞLIĞI / COLLET CHUCK	2-10 mm	32	63
511430	SK 40 - 430 ER 25 PENS BAŞLIĞI / COLLET CHUCK	2-16 mm	42	60
511470	SK 40 - 470 ER 32 PENS BAŞLIĞI / COLLET CHUCK	2-20 mm	50	70
511472	SK 40 - 472 ER 40 PENS BAŞLIĞI / COLLET CHUCK	2-26 mm	63	80
515426	SK 50 - 426 ER 16 PENS BAŞLIĞI / COLLET CHUCK	2-10 mm	32	63
515430	SK 50 - 430 ER 25 PENS BAŞLIĞI / COLLET CHUCK	2-16 mm	42	60
515470	SK 50 - 470 ER 32 PENS BAŞLIĞI / COLLET CHUCK	2-20 mm	50	70
515472	SK 50 - 472 ER 40 PENS BAŞLIĞI / COLLET CHUCK	2-26 mm	63	80

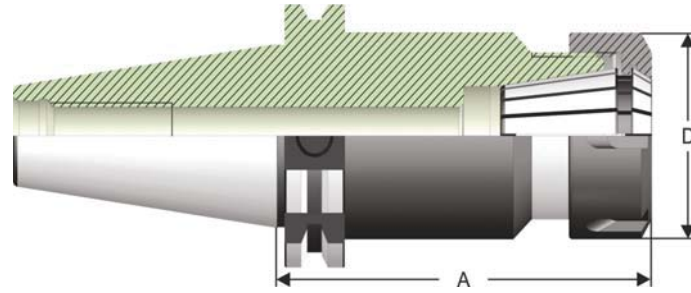

Sipariş Kodu Order Number	Ürün Adı Product Name	Kapasite Capacity (d)	D	A
510426-1	SK 30 - 426 ER 16 PENS BAŞLIĞI / COLLET CHUCK	2-10 mm	32	100
510430-1	SK 30 - 430 ER 25 PENS BAŞLIĞI / COLLET CHUCK	2-16 mm	42	100
510470-1	SK 30 - 470 ER 32 PENS BAŞLIĞI / COLLET CHUCK	2-20 mm	50	100
512426-1	SK 40 - 426 ER 16 PENS BAŞLIĞI MİNİ / COLLET CHUCK	2-10 mm	22	100
512426	SK 40 - 426 ER 16 PENS BAŞLIĞI / COLLET CHUCK	2-10 mm	32	100
512430	SK 40 - 430 ER 25 PENS BAŞLIĞI / COLLET CHUCK	2-16 mm	42	100
512470	SK 40 - 470 ER 32 PENS BAŞLIĞI / COLLET CHUCK	2-20 mm	50	100
512472	SK 40 - 472 ER 40 PENS BAŞLIĞI / COLLET CHUCK	2-26 mm	63	100
516426	SK 50 - 426 ER 16 PENS BAŞLIĞI / COLLET CHUCK	2-10 mm	32	100
516426-1	SK 50 - 426 ER 16 PENS BAŞLIĞI MİNİ / COLLET CHUCK	2-10 mm	22	100
516430	SK 50 - 430 ER 25 PENS BAŞLIĞI / COLLET CHUCK	2-16 mm	42	100
516470	SK 50 - 470 ER 32 PENS BAŞLIĞI / COLLET CHUCK	2-20 mm	50	100
516472	SK 50 - 472 ER 40 PENS BAŞLIĞI / COLLET CHUCK	2-26 mm	63	100



DEĞERLİ
www.degerlimakina.com

DIN 69871 AD

DIN 6499 ER SERİSİ PENS BAŞLIĞI

DIN 6499 ER SERIES COLLET CHUCK

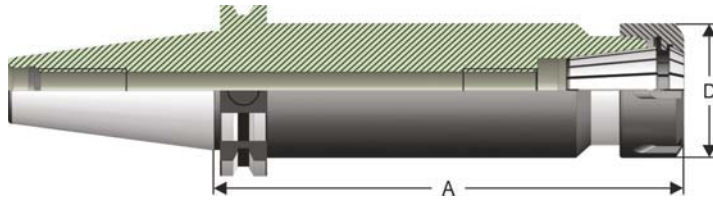

Sipariş Kodu Order Number	Ürün Adı Product Name	Kapasite Capacity (d)	D	A
513426-1	SK 40 - 426 ER 16 PENS BAŞLIĞI MİNİ / COLLET CHUCK	2-10 mm	22	160
513426	SK 40 - 426 ER 16 PENS BAŞLIĞI / COLLET CHUCK	2-10 mm	32	160
513430	SK 40 - 430 ER 25 PENS BAŞLIĞI / COLLET CHUCK	2-16 mm	42	160
513470	SK 40 - 470 ER 32 PENS BAŞLIĞI / COLLET CHUCK	2-20 mm	50	160
513472	SK 40 - 472 ER 40 PENS BAŞLIĞI / COLLET CHUCK	2-26 mm	63	160
517426-1	SK 50 - 426 ER 16 PENS BAŞLIĞI MİNİ / COLLET CHUCK	2-10 mm	22	160
517426	SK 50 - 426 ER 16 PENS BAŞLIĞI / COLLET CHUCK	2-10 mm	32	160
517430	SK 50 - 430 ER 25 PENS BAŞLIĞI / COLLET CHUCK	2-16 mm	42	160
517470	SK 50 - 470 ER 32 PENS BAŞLIĞI / COLLET CHUCK	2-20 mm	50	160
517472	SK 50 - 472 ER 40 PENS BAŞLIĞI / COLLET CHUCK	2-26 mm	63	160

DIN 64871 AD**DIN 6499 HASSAS AYARLANABİLİR PENS BAŞLIĞI**

DIN 6499 ADJUSTABLE TOOL HOOLDER

DEĞERLİ®

www.degerlimakina.com

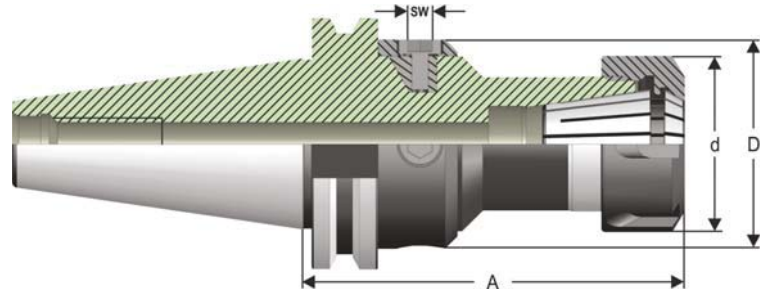

Sipariş Kodu Order Number	Ürün Adı Product Name	Kapasite Capacity	D	A	d	SW
514430	SK 40 - 430 ER 25 HAS.AYAR. PENS BAŞLIĞI / ADJUSTABLE TOOL HOOLDER	2-16 mm	50	85	42	5
514470	SK 40 - 470 ER 32 HAS.AYAR. PENS BAŞLIĞI / ADJUSTABLE TOOL HOOLDER	2-20 mm	50	90	50	5
514472	SK 40 - 472 ER 40 HAS.AYAR. PENS BAŞLIĞI / ADJUSTABLE TOOL HOOLDER	2-26 mm	60	115	63	5
518470	SK 50 - 470 ER 32 HAS.AYAR. PENS BAŞLIĞI / ADJUSTABLE TOOL HOOLDER	2-20 mm	50	90	50	5
518472	SK 50 - 472 ER 40 HAS.AYAR. PENS BAŞLIĞI / ADJUSTABLE TOOL HOOLDER	2-26 mm	60	100	63	5



DEĞERLİ
www.degerlimakina.com

DIN 69871 AD

RULMANLI PENS BAŞLIĞI

PRECISION MILLING CHUCK

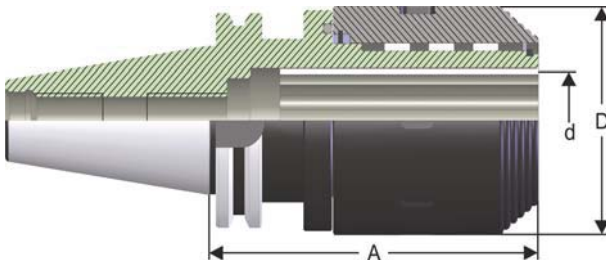

SAYFA/PAGE: H-17



SAYFA/PAGE: H-04



SAYFA/PAGE: A-21/23



SAYFA/PAGE: F-28



SAYFA/PAGE: H-13



SAYFA/PAGE: H-12



VN5



58-60 HRC

Sipariş Kodu Order Number	Ürün Adı Product Name	Kapasite Capacity (d)	A	D
518420	SK 40 - RULMANLI PENS BAŞLIĞI / PRECISION MILLING CHUCK	6-20 mm	90	49
518432	SK 40 - RULMANLI PENS BAŞLIĞI / PRECISION MILLING CHUCK	6-32 mm	100	68
519520	SK 50 - RULMANLI PENS BAŞLIĞI / PRECISION MILLING CHUCK	6-20 mm	70	49
519532	SK 50 - RULMANLI PENS BAŞLIĞI / PRECISION MILLING CHUCK	6-32 mm	95	68

DIN 69871 AD**DIN 6358 KOMBİNE TARAMA TUTUCUSU**

DIN 6358 COMBI SHELL MILL HOLDER

DEĞERLİ
www.degerlimakina.com

SAYFA/PAGE: H-17



SAYFA/PAGE: H-25



SAYFA/PAGE: H-24



SAYFA/PAGE: H-13



SAYFA/PAGE: H-12



VN5



58-60 HRC

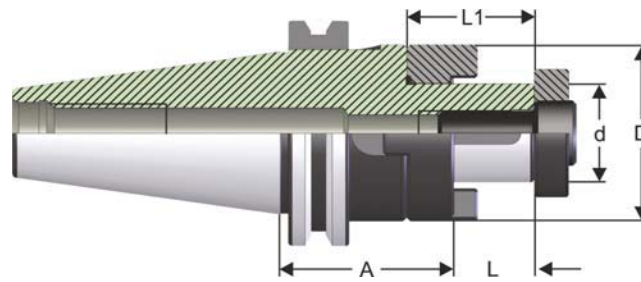

Sipariş Kodu Order Number	Ürün Adı Product Name	d h6	D	A	L	L1
523016	SK 30 - K.T.B. 16 / COMBI SHELL MILL HOLDER	16	32	50	17	27
523022	SK 30 - K.T.B. 22 / COMBI SHELL MILL HOLDER	22	40	50	19	31
523027	SK 30 - K.T.B. 27 / COMBI SHELL MILL HOLDER	27	48	55	21	33
523032	SK 30 - K.T.B. 32 / COMBI SHELL MILL HOLDER	32	58	60	24	38
524016	SK 40 - K.T.B. 16 / COMBI SHELL MILL HOLDER	16	32	55	17	27
524022	SK 40 - K.T.B. 22 / COMBI SHELL MILL HOLDER	22	40	55	19	31
524027	SK 40 - K.T.B. 27 / COMBI SHELL MILL HOLDER	27	48	55	21	33
524032	SK 40 - K.T.B. 32 / COMBI SHELL MILL HOLDER	32	58	60	24	38
524040	SK 40 - K.T.B. 40 / COMBI SHELL MILL HOLDER	40	70	60	27	41
525016	SK 50 - K.T.B. 16 / COMBI SHELL MILL HOLDER	16	32	55	17	27
525022	SK 50 - K.T.B. 22 / COMBI SHELL MILL HOLDER	22	40	55	19	31
525027	SK 50 - K.T.B. 27 / COMBI SHELL MILL HOLDER	27	48	55	21	33
525032	SK 50 - K.T.B. 32 / COMBI SHELL MILL HOLDER	32	58	55	24	38
525040	SK 50 - K.T.B. 40 / COMBI SHELL MILL HOLDER	40	70	55	27	41



DEĞERLİ
www.degerlimakina.com

DIN 69871 AD

DIN 6358 KOMBİNE TARAMA TUTUCUSU

DIN 6358 COMBI SHELL MILL HOLDER

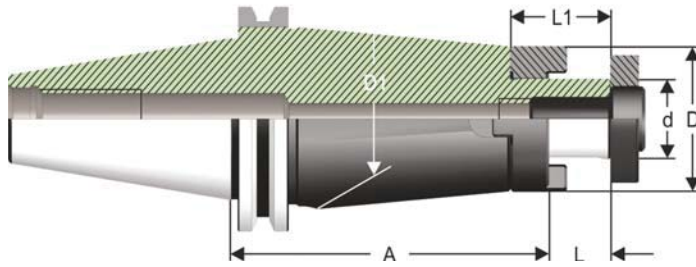

Sipariş Kodu Order Number	Ürün Adı Product Name	d h6	D	A	L	L1	D1
524116	SK 40 - K.T.B. 16 / COMBI SHELL MILL HOLDER	16	32	100	17	27	38
524122	SK 40 - K.T.B. 22 / COMBI SHELL MILL HOLDER	22	40	100	19	31	48
524127	SK 40 - K.T.B. 27 / COMBI SHELL MILL HOLDER	27	48	100	21	33	50
524132	SK 40 - K.T.B. 32 / COMBI SHELL MILL HOLDER	32	58	100	24	38	58
524140	SK 40 - K.T.B. 40 / COMBI SHELL MILL HOLDER	40	70	100	27	41	70
525116	SK 50 - K.T.B. 16 / COMBI SHELL MILL HOLDER	16	32	100	17	27	38
525122	SK 50 - K.T.B. 22 / COMBI SHELL MILL HOLDER	22	40	100	19	31	48
525127	SK 50 - K.T.B. 27 / COMBI SHELL MILL HOLDER	27	48	100	21	33	58
525132	SK 50 - K.T.B. 32 / COMBI SHELL MILL HOLDER	32	58	100	24	38	68
525140	SK 50 - K.T.B. 40 / COMBI SHELL MILL HOLDER	40	70	100	27	41	80

DIN 69871 AD**DIN 6358 KOMBİNE TARAMA TUTUCUSU**

DIN 6358 COMBI SHELL MILL HOLDER

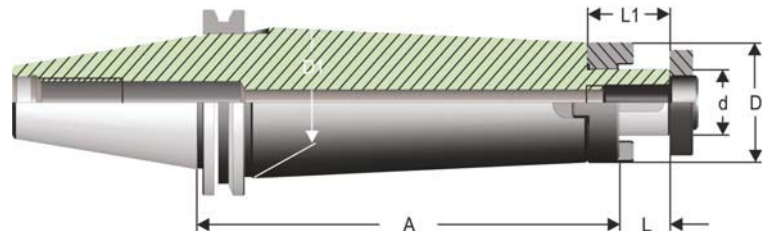
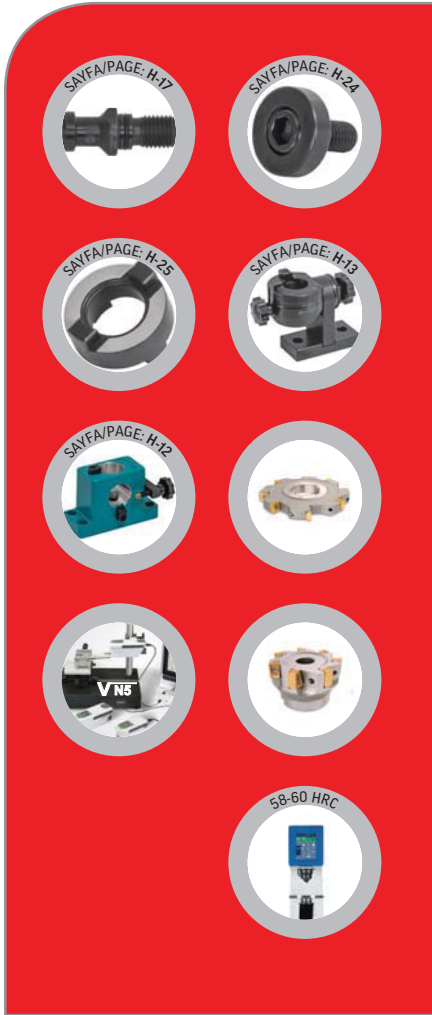
DEĞERLİ
www.degerlimakina.com

Sipariş Kodu Order Number	Ürün Adı Product Name	d h6	D	A	L	L1	D1
524116.1	SK 40 - K.T.B. 16 / COMBI SHELL MILL HOLDER	16	32	160	17	27	38
524122.1	SK 40 - K.T.B. 22 / COMBI SHELL MILL HOLDER	22	40	160	19	31	48
524127.1	SK 40 - K.T.B. 27 / COMBI SHELL MILL HOLDER	27	48	160	21	33	50
524132.1	SK 40 - K.T.B. 32 / COMBI SHELL MILL HOLDER	32	58	160	24	38	58
524140.1	SK 40 - K.T.B. 40 / COMBI SHELL MILL HOLDER	40	70	160	27	41	70
525116.1	SK 50 - K.T.B. 16 / COMBI SHELL MILL HOLDER	16	32	160	17	27	38
525122.1	SK 50 - K.T.B. 22 / COMBI SHELL MILL HOLDER	22	40	160	19	31	48
525127.1	SK 50 - K.T.B. 27 / COMBI SHELL MILL HOLDER	27	48	160	21	33	58
525132.1	SK 50 - K.T.B. 32 / COMBI SHELL MILL HOLDER	32	58	160	24	38	68
525140.1	SK 50 - K.T.B. 40 / COMBI SHELL MILL HOLDER	40	70	160	27	41	80

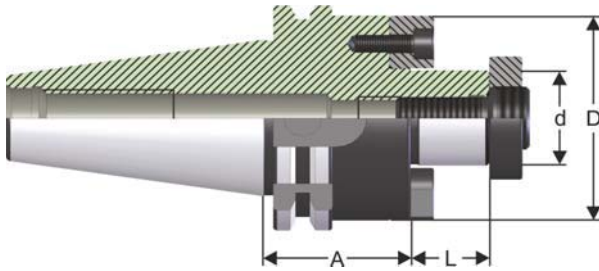

Sipariş Kodu Order Number	Ürün Adı Product Name	d h6	D	A	L
533016	SK 30 - A.T.B. 16 / SHELL MILL HOLDER	16	38	40	17
533022	SK 30 - A.T.B. 22 / SHELL MILL HOLDER	22	48	40	19
533027	SK 30 - A.T.B. 27 / SHELL MILL HOLDER	27	58	50	21
533032	SK 30 - A.T.B. 32 / SHELL MILL HOLDER	32	78	50	24
534016	SK 40 - A.T.B. 16 / SHELL MILL HOLDER	16	38	35	17
534022	SK 40 - A.T.B. 22 / SHELL MILL HOLDER	22	48	35	19
534027	SK 40 - A.T.B. 27 / SHELL MILL HOLDER	27	58	40	21
534032	SK 40 - A.T.B. 32 / SHELL MILL HOLDER	32	78	50	24
534040	SK 40 - A.T.B. 40 / SHELL MILL HOLDER	40	88	50	27
535016	SK 50 - A.T.B. 16 / SHELL MILL HOLDER	16	38	35	17
535022	SK 50 - A.T.B. 22 / SHELL MILL HOLDER	22	48	35	19
535027	SK 50 - A.T.B. 27 / SHELL MILL HOLDER	27	58	40	21
535032	SK 50 - A.T.B. 32 / SHELL MILL HOLDER	32	78	50	24
535040	SK 50 - A.T.B. 40 / SHELL MILL HOLDER	40	88	50	27
535060	SK 50 - A.T.B. 60 / SHELL MILL HOLDER	60	128	70	40

DIN 69871 AD

SK 30 DIN 6359 VELDON TUTUCU - DIN 1835-B

SK 30 DIN 6359 END MILL HOLDER - DIN 1835-B

DEĞERLİ®

www.degerlimakina.com

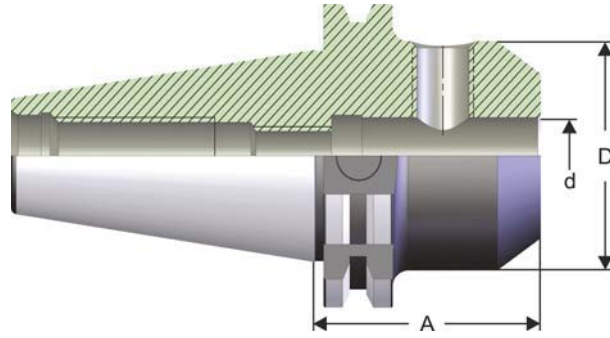

Sipariş Kodu Order Number	Ürün Adı Product Name	d h4	D	A
543006	SK 30 VELDON / END MILL HOLDER	6	25	50
543008	SK 30 VELDON / END MILL HOLDER	8	28	50
543010	SK 30 VELDON / END MILL HOLDER	10	35	50
543012	SK 30 VELDON / END MILL HOLDER	12	42	50
543014	SK 30 VELDON / END MILL HOLDER	14	44	63
543016	SK 30 VELDON / END MILL HOLDER	16	48	63
543018	SK 30 VELDON / END MILL HOLDER	18	50	63
543020	SK 30 VELDON / END MILL HOLDER	20	52	70



DEĞERLİ
www.degerlimakina.com

DIN 69871 AD

SK 40 DIN 6359 VELDON TUTUCU - DIN 1835-B

SK 40 DIN 6359 END MILL HOLDER - DIN 1835-B

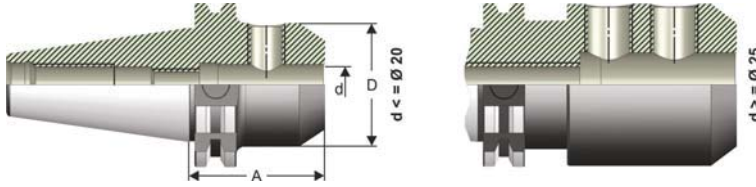

Sipariş Kodu Order Number	Ürün Adı Product Name	d h4	D	A
544006	SK 40 VELDON / END MILL HOLDER	6	25	50
544008	SK 40 VELDON / END MILL HOLDER	8	28	50
544010	SK 40 VELDON / END MILL HOLDER	10	35	50
544012	SK 40 VELDON / END MILL HOLDER	12	42	50
544014	SK 40 VELDON / END MILL HOLDER	14	44	50
544016	SK 40 VELDON / END MILL HOLDER	16	48	63
544018	SK 40 VELDON / END MILL HOLDER	18	50	63
544020	SK 40 VELDON / END MILL HOLDER	20	52	63
544025	SK 40 VELDON / END MILL HOLDER	25	63	100
544032	SK 40 VELDON / END MILL HOLDER	32	72	100
544040	SK 40 VELDON / END MILL HOLDER	40	79	120

DIN 69871 AD

SK 40 DIN 6359 VELDON TUTUCU - DIN 1835-B

SK 40 DIN 6359 END MILL HOLDER - DIN 1835-B

DEĞERLİ®

www.degerlimakina.com



SAYFA/PAGE: H-17



SAYFA/PAGE: H-21



SAYFA/PAGE: H-13



SAYFA/PAGE: H-12



58-60 HRC

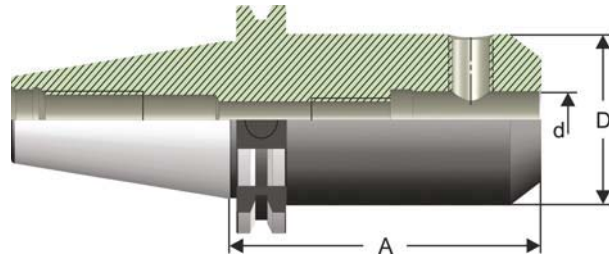

Sipariş Kodu Order Number	Ürün Adı Product Name	d h4	D	A
544106	SK 40 VELDON / END MILL HOLDER	6	25	100
544108	SK 40 VELDON / END MILL HOLDER	8	28	100
544110	SK 40 VELDON / END MILL HOLDER	10	35	100
544112	SK 40 VELDON / END MILL HOLDER	12	42	100
544114	SK 40 VELDON / END MILL HOLDER	14	44	100
544116	SK 40 VELDON / END MILL HOLDER	16	48	100
544118	SK 40 VELDON / END MILL HOLDER	18	50	100
544120	SK 40 VELDON / END MILL HOLDER	20	52	100



DEĞERLİ
www.degerlimakina.com

DIN 69871 AD

SK 40 DIN 6359 VELDON TUTUCU - DIN 1835-B

SK 40 DIN 6359 END MILL HOLDER - DIN 1835-B

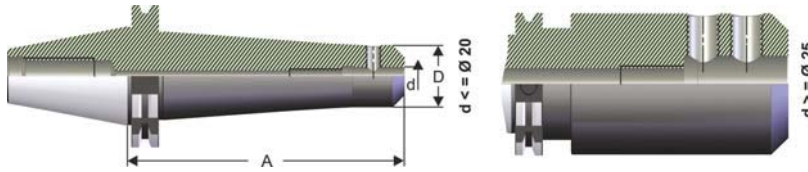

Sipariş Kodu Order Number	Ürün Adı Product Name	d h4	D	A
544106.1	SK 40 VELDON / END MILL HOLDER	6	25	160
544108.1	SK 40 VELDON / END MILL HOLDER	8	28	160
544110.1	SK 40 VELDON / END MILL HOLDER	10	35	160
544112.1	SK 40 VELDON / END MILL HOLDER	12	42	160
544114.1	SK 40 VELDON / END MILL HOLDER	14	44	160
544116.1	SK 40 VELDON / END MILL HOLDER	16	48	160
544118.1	SK 40 VELDON / END MILL HOLDER	18	50	160
544120.1	SK 40 VELDON / END MILL HOLDER	20	52	160
544125.1	SK 40 VELDON / END MILL HOLDER	25	63	160
544132.1	SK 40 VELDON / END MILL HOLDER	32	72	160



SAYFA/PAGE: H-17



SAYFA/PAGE: H-21



SAYFA/PAGE: H-13



SAYFA/PAGE: H-12



58-60 HRC

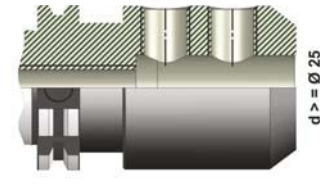
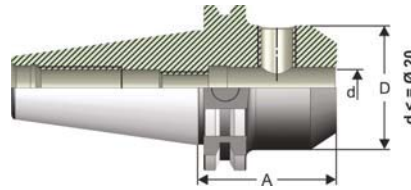

Sipariş Kodu Order Number	Ürün Adı Product Name	d h4	D	A
545006	SK 50 VELDON / END MILL HOLDER	6	25	63
545008	SK 50 VELDON / END MILL HOLDER	8	28	63
545010	SK 50 VELDON / END MILL HOLDER	10	35	63
545012	SK 50 VELDON / END MILL HOLDER	12	42	63
545014	SK 50 VELDON / END MILL HOLDER	14	44	63
545016	SK 50 VELDON / END MILL HOLDER	16	48	63
545018	SK 50 VELDON / END MILL HOLDER	18	50	63
545020	SK 50 VELDON / END MILL HOLDER	20	52	63
545025	SK 50 VELDON / END MILL HOLDER	25	65	80
545032	SK 50 VELDON / END MILL HOLDER	32	72	100
545040	SK 50 VELDON / END MILL HOLDER	40	80	110



DEĞERLİ
www.degerlimakina.com

DIN 69871 AD

SK 50 DIN 6359 VELDON TUTUCU - DIN 1835-B

SK 50 DIN 6359 END MILL HOLDER - DIN 1835-B

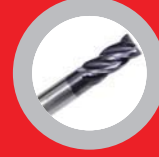
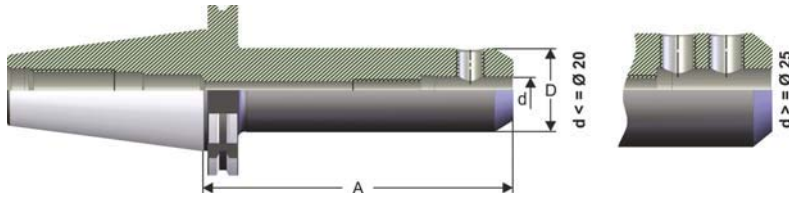

Sipariş Kodu Order Number	Ürün Adı Product Name	d h4	D	A
545106	SK 50 VELDON / END MILL HOLDER	6	25	160
545108	SK 50 VELDON / END MILL HOLDER	8	28	160
545110	SK 50 VELDON / END MILL HOLDER	10	35	160
545112	SK 50 VELDON / END MILL HOLDER	12	42	160
545114	SK 50 VELDON / END MILL HOLDER	14	44	160
545116	SK 50 VELDON / END MILL HOLDER	16	48	160
545118	SK 50 VELDON / END MILL HOLDER	18	50	160
545120	SK 50 VELDON / END MILL HOLDER	20	52	160
545125	SK 50 VELDON / END MILL HOLDER	25	65	160
545132	SK 50 VELDON / END MILL HOLDER	32	72	160
545140	SK 50 VELDON / END MILL HOLDER	40	80	160

DIN 99871 AD

KAMALI MORS ADAPTÖRÜ DIN 6383

MORSE TAPER ADTOR TANG DIN 6383

DEĞERLİ®

www.degerlimakina.com

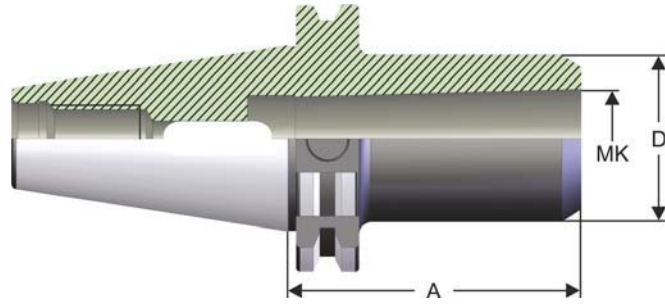

Sipariş Kodu Order Number	Ürün Adı Product Name	Mk Morse	D	A
553001	SK 30 KAMALI MORS ADAPTÖRÜ / MORSE TAPER ADAPTOR TANG	1	25	50
553002	SK 30 KAMALI MORS ADAPTÖRÜ / MORSE TAPER ADAPTOR TANG	2	32	65
553003	SK 30 KAMALI MORS ADAPTÖRÜ / MORSE TAPER ADAPTOR TANG	3	40	80
554001	SK 40 KAMALI MORS ADAPTÖRÜ / MORSE TAPER ADAPTOR TANG	1	25	50
554002	SK 40 KAMALI MORS ADAPTÖRÜ / MORSE TAPER ADAPTOR TANG	2	32	50
554003	SK 40 KAMALI MORS ADAPTÖRÜ / MORSE TAPER ADAPTOR TANG	3	40	70
554004	SK 40 KAMALI MORS ADAPTÖRÜ / MORSE TAPER ADAPTOR TANG	4	48	95
555001	SK 50 KAMALI MORS ADAPTÖRÜ / MORSE TAPER ADAPTOR TANG	1	25	45
555002	SK 50 KAMALI MORS ADAPTÖRÜ / MORSE TAPER ADAPTOR TANG	2	32	60
555003	SK 50 KAMALI MORS ADAPTÖRÜ / MORSE TAPER ADAPTOR TANG	3	40	65
555004	SK 50 KAMALI MORS ADAPTÖRÜ / MORSE TAPER ADAPTOR TANG	4	48	95
555005	SK 50 KAMALI MORS ADAPTÖRÜ / MORSE TAPER ADAPTOR TANG	5	63	105



DEĞERLİ
www.degerlimakina.com

DIN 69871 AD

ÇEKTİRMELİ MORS ADAPTÖRÜ DIN 6364

MORSE TAPER ADTOR DRAWBAR DIN 6364

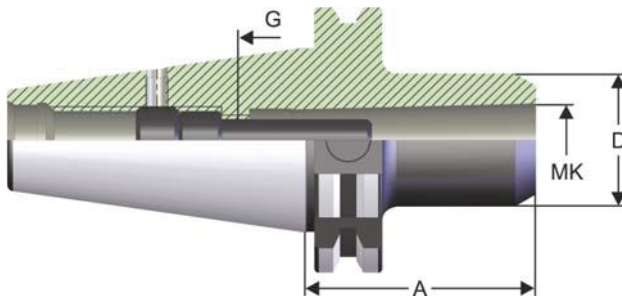

Sipariş Kodu Order Number	Ürün Adı Product Name	Mk Morse	D	A	G
564001	SK 40 ÇEK. MORS ADAPTÖRÜ / MORSE TAPER ADAPTOR DRAWBAR	1	25	50	M6
564002	SK 40 ÇEK. MORS ADAPTÖRÜ / MORSE TAPER ADAPTOR DRAWBAR	2	32	55	M10
564003	SK 40 ÇEK. MORS ADAPTÖRÜ / MORSE TAPER ADAPTOR DRAWBAR	3	40	70	M12
564004	SK 40 ÇEK. MORS ADAPTÖRÜ / MORSE TAPER ADAPTOR DRAWBAR	4	48	95	M16
565001	SK 50 ÇEK. MORS ADAPTÖRÜ / MORSE TAPER ADAPTOR DRAWBAR	1	25	45	M6
565002	SK 50 ÇEK. MORS ADAPTÖRÜ / MORSE TAPER ADAPTOR DRAWBAR	2	32	60	M10
565003	SK 50 ÇEK. MORS ADAPTÖRÜ / MORSE TAPER ADAPTOR DRAWBAR	3	40	65	M12
565004	SK 50 ÇEK. MORS ADAPTÖRÜ / MORSE TAPER ADAPTOR DRAWBAR	4	48	85	M16
565005	SK 50 ÇEK. MORS ADAPTÖRÜ / MORSE TAPER ADAPTOR DRAWBAR	5	63	118	M20

DIN 69871 AD

MANDREN BAŞLIĞI DIN 238
DRILL CHUCK ADAPTOR DIN 238

DEĞERLİ®
www.degerlimakina.com

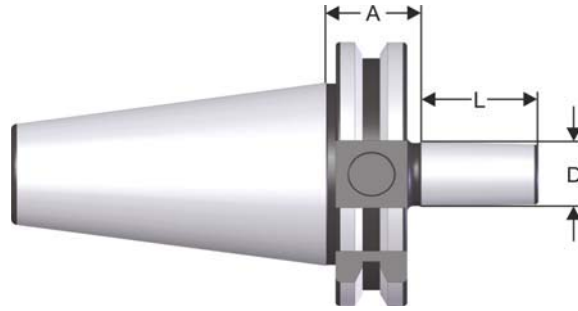

Sipariş Kodu Order Number	Ürün Adı Product Name	D	A	L
573012	SK 30 MANDREN ADAPTÖRÜ / DRILL CHUCK ADAPTOR	B12	38,5	18,5
573016	SK 30 MANDREN ADAPTÖRÜ / DRILL CHUCK ADAPTOR	B16	40	24
574012	SK 40 MANDREN ADAPTÖRÜ / DRILL CHUCK ADAPTOR	B12	25	18,5
574016	SK 40 MANDREN ADAPTÖRÜ / DRILL CHUCK ADAPTOR	B16	25	24
574018	SK 40 MANDREN ADAPTÖRÜ / DRILL CHUCK ADAPTOR	B18	35	32
575016	SK 50 MANDREN ADAPTÖRÜ / DRILL CHUCK ADAPTOR	B16	25	24
575018	SK 50 MANDREN ADAPTÖRÜ / DRILL CHUCK ADAPTOR	B18	25	32



DEĞERLİ
www.degerlimakina.com

DIN 69871 AD

NC TİPİ MANDREN TUTUCU

NC DRILL CHUCK

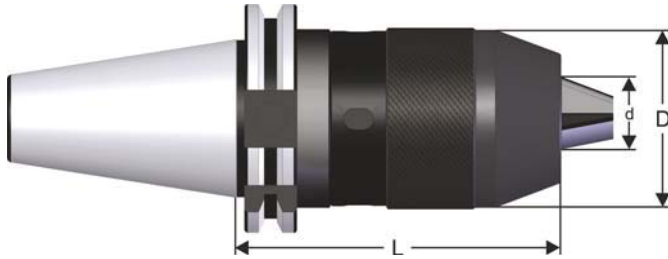

SAVFA/PAGE: H-17



SAVFA/PAGE: H-13



SAVFA/PAGE: H-04



V N5



58-60 HRC



Sipariş Kodu
Order Number

Ürün Adı
Product Name

Kapasite
Capacity (d)

D

L

574116

SK 40 NC MANDREN TUTUCU / NC DRILL CHUCK

1-16

51

99

575116

SK 50 NC MANDREN TUTUCU / NC DRILL CHUCK

1-16

51

89

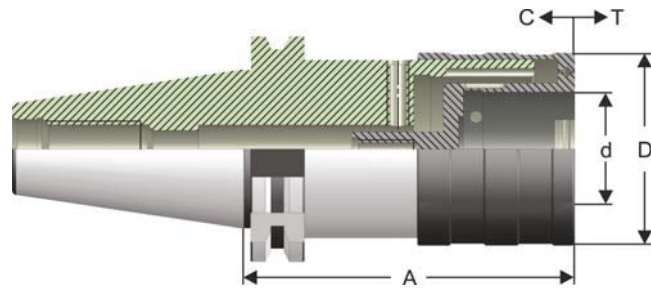

Sipariş Kodu Order Number	Ürün Adı Product Name	d	A	D	C	T
576214	SK 30 M2 - M14 EM.TİP KLV.ÇEK.BAŞ. / QUICK-CHANGE TAPPING CHUCK	19	66	38	7	7
576524	SK 30 M5 - M24 EM.TİP KLV.ÇEK.BAŞ. / QUICK-CHANGE TAPPING CHUCK	31	99	54	12	12
577214	SK 40 M2 - M14 EM.TİP KLV.ÇEK.BAŞ. / QUICK-CHANGE TAPPING CHUCK	19	64	38	7	7
577524	SK 40 M5 - M24 EM.TİP KLV.ÇEK.BAŞ. / QUICK-CHANGE TAPPING CHUCK	31	97	54	12	12
5771436	SK 40 M14 - M36 EM.TİP KLV.ÇEK.BAŞ. / QUICK-CHANGE TAPPING CHUCK	48	136	78	17,5	17,5
578214	SK 50 M2 - M14 EM.TİP KLV.ÇEK.BAŞ. / QUICK-CHANGE TAPPING CHUCK	19	62	38	7	7
578524	SK 50 M5 - M24 EM.TİP KLV.ÇEK.BAŞ. / QUICK-CHANGE TAPPING CHUCK	31	85	54	12	12
5781436	SK 50 M14 - M36 EM.TİP KLV.ÇEK.BAŞ. / QUICK-CHANGE TAPPING CHUCK	48	138	78	17,5	17,5



DEĞERLİ
www.degerlimakina.com

DIN 69871 AD

VİDALI FREZE TAKIM TUTUCULARI

SET HOLDERS FOR SCREW MILLING CUTTERS

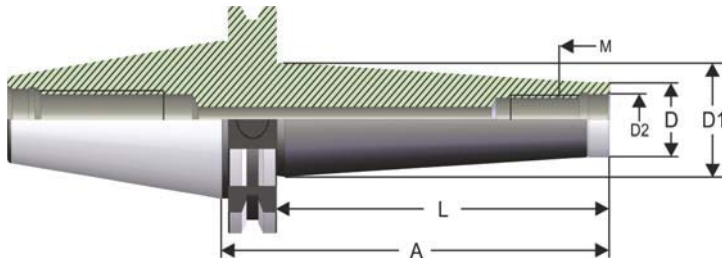

Sipariş Kodu Order Number	Ürün Adı Product Name	M	D	D1	A	L	D2
584008	SK 40 VİDALI TAKIM TUTUCU / SET HOLDERS FOR SCREW MILLING CUTTERS	M8	13	23	69	50	8,5
584008.1	SK 40 VİDALI TAKIM TUTUCU / SET HOLDERS FOR SCREW MILLING CUTTERS	M8	13	25	119	100	8,5
584008.2	SK 40 VİDALI TAKIM TUTUCU / SET HOLDERS FOR SCREW MILLING CUTTERS	M8	13	30	169	150	8,5
584010	SK 40 VİDALI TAKIM TUTUCU / SET HOLDERS FOR SCREW MILLING CUTTERS	M10	18	23	69	50	10,5
584010.1	SK 40 VİDALI TAKIM TUTUCU / SET HOLDERS FOR SCREW MILLING CUTTERS	M10	18	32	119	100	10,5
584010.2	SK 40 VİDALI TAKIM TUTUCU / SET HOLDERS FOR SCREW MILLING CUTTERS	M10	18	36	169	150	10,5
584012	SK 40 VİDALI TAKIM TUTUCU / SET HOLDERS FOR SCREW MILLING CUTTERS	M12	21	24	69	50	12,5
584012.1	SK 40 VİDALI TAKIM TUTUCU / SET HOLDERS FOR SCREW MILLING CUTTERS	M12	21	33	119	100	12,5
584012.2	SK 40 VİDALI TAKIM TUTUCU / SET HOLDERS FOR SCREW MILLING CUTTERS	M12	21	40	169	150	12,5
584016	SK 40 VİDALI TAKIM TUTUCU / SET HOLDERS FOR SCREW MILLING CUTTERS	M16	29	34	94	75	17
584016.0	SK 40 VİDALI TAKIM TUTUCU / SET HOLDERS FOR SCREW MILLING CUTTERS	M16	29	29	44	25	17
584016.1	SK 40 VİDALI TAKIM TUTUCU / SET HOLDERS FOR SCREW MILLING CUTTERS	M16	29	40	144	125	17

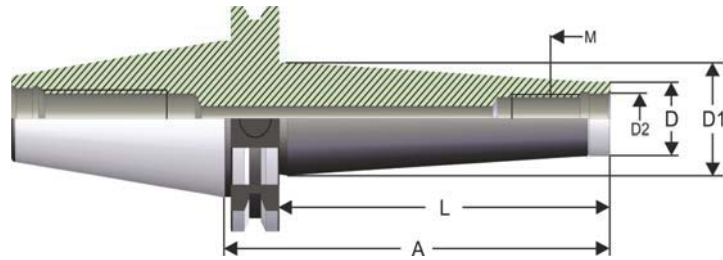
DIN 69871 AD**VİDALI FREZE TAKIM TUTUCULARI**
SET HOLDERS FOR SCREW MILLING CUTTERS**DEĞERLİ**
www.degerlimakina.com

Sipariş Kodu Order Number	Ürün Adı Product Name	M	D	D1	A	L	D2
585008	SK 50 VİDALI TAKIM TUTUCU / SET HOLDERS FOR SCREW MILLING CUTTERS	M8	13	25	119	100	8,5
585008.1	SK 50 VİDALI TAKIM TUTUCU / SET HOLDERS FOR SCREW MILLING CUTTERS	M8	13	30	169	150	8,5
585010	SK 50 VİDALI TAKIM TUTUCU / SET HOLDERS FOR SCREW MILLING CUTTERS	M10	18	32	119	100	10,5
585010.1	SK 50 VİDALI TAKIM TUTUCU / SET HOLDERS FOR SCREW MILLING CUTTERS	M10	18	36	169	150	10,5
585012	SK 50 VİDALI TAKIM TUTUCU / SET HOLDERS FOR SCREW MILLING CUTTERS	M12	21	33	119	100	12,5
585012.1	SK 50 VİDALI TAKIM TUTUCU / SET HOLDERS FOR SCREW MILLING CUTTERS	M12	21	40	169	150	12,5
585016	SK 50 VİDALI TAKIM TUTUCU / SET HOLDERS FOR SCREW MILLING CUTTERS	M16	29	36	119	100	17
585016.1	SK 50 VİDALI TAKIM TUTUCU / SET HOLDERS FOR SCREW MILLING CUTTERS	M16	29	42	169	150	17



DEĞERLİ
www.degerlimakina.com

DIN 69871 AD

ÖZEL TAKIM YAPMAK İÇİN YUMUŞAK BARA

BORING BAR BLANKS FOR PRODUCING SPECIAL TOOL

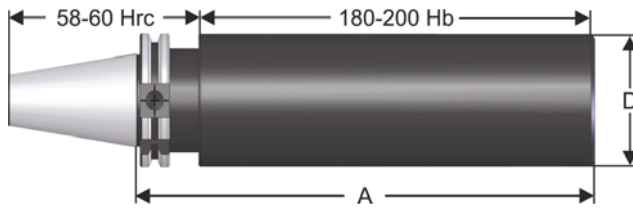

Sipariş Kodu Order Number	Ürün Adı Product Name	D	A
594000	SK 40 ÖZEL TAKIM HAM BARA / BORING BAR BLANKS	63	250
595000	SK 50 ÖZEL TAKIM HAM BARA / BORING BAR BLANKS	97	315

DIN 69871 AD**DIN 6388-B PENS TAKIMLARI**

DIN 6388-B COLLET SET IN BOX

DEĞERLİ®

www.degerlimakina.com



Sipariş Kodu Order Number	Ürün Adı Product Name	Adet Piece	Ölçüler Contents
593415	SK 30 - 415 PENS TAKIMI 415 COLLET SET IN BOX	16	3-4-5-6-7-8-9-10-11-12-13-14-15-16 - 904042 - 510415
593462	SK 30 - 462 PENS TAKIMI 462 COLLET SET IN BOX	18	4-5-6-7-8-9-10-11-12-14-16-18-20-22-24-25 - 905862 - 510462
594415	SK 40 - 415 PENS TAKIMI 415 COLLET SET IN BOX	16	3-4-5-6-7-8-9-10-11-12-13-14-15-16 - 904042 - 511415
594462	SK 40 - 462 PENS TAKIMI 462 COLLET SET IN BOX	18	4-5-6-7-8-9-10-11-12-14-16-18-20-22-24-25 - 905862 - 511462
594467	SK 40 - 467 PENS TAKIMI 467 COLLET SET IN BOX	18	5-6-7-8-10-12-14-16-18-20-22-24-25-28-30-32 - 906875 - 511467
595462	SK 50 - 462 PENS TAKIMI 462 COLLET SET IN BOX	18	4-5-6-7-8-9-10-11-12-14-16-18-20-22-24-25 - 905862 - 515462
595467	SK 50 - 467 PENS TAKIMI 467 COLLET SET IN BOX	18	5-6-7-8-10-12-14-16-18-20-22-24-25-28-30-32 - 906875 - 515467
595468	SK 50 - 468 PENS TAKIMI 468 COLLET SET IN BOX	22	6-7-8-9-10-12-14-16-18-20-22-24-25-28-30-32-34-36-38-40 - 908590 - 515468



DEĞERLİ
www.degerlimakina.com

DIN 69871 AD

DIN 6499 / ER SERİSİ TAKIMLAR

DIN 6499 / COLLET SET IN BOX ER SERIES



Sipariş Kodu Order Number	Ürün Adı Product Name	Adet Piece	Ölçüler Contents
593430	SK 30 - 430 PENS TAKIMI 430 COLLET SET İN BOX	14	3-4-5-6-7-8-9-10-11-12-14-16 - 9042430 - 510430
593470	SK 30 - 470 PENS TAKIMI 470 COLLET SET İN BOX	16	3-4-5-6-7-8-9-10-11-12-14-16-18-20 - 9050470 - 510470
593472	SK 30 - 472 PENS TAKIMI 472 COLLET SET İN BOX	18	4-5-6-7-8-9-10-11-12-14-16-18-20-22-24-26 - 9063472 - 510472
594430	SK 40 - 430 PENS TAKIMI 430 COLLET SET İN BOX	14	3-4-5-6-7-8-9-10-11-12-14-16 - 9042430 - 511430
594470	SK 40 - 470 PENS TAKIMI 470 COLLET SET İN BOX	16	3-4-5-6-7-8-9-10-11-12-14-16-18-20 - 9050470 - 511470
594472	SK 40 - 472 PENS TAKIMI 472 COLLET SET İN BOX	18	4-5-6-7-8-9-10-11-12-14-16-18-20-22-24-26 - 9063472 - 511472
595430	SK 50 - 430 PENS TAKIMI 430 COLLET SET İN BOX	14	3-4-5-6-7-8-9-10-11-12-14-16 - 9042430 - 515430
595470	SK 50 - 470 PENS TAKIMI 470 COLLET SET İN BOX	16	3-4-5-6-7-8-9-10-11-12-14-16-18-20 - 9050470 - 515470
595472	SK 50 - 472 PENS TAKIMI 472 COLLET SET İN BOX	18	4-5-6-7-8-9-10-11-12-14-16-18-20-22-24-26 - 9063472 - 515472

DIN 69871 AD

RULMANLI PENS TAKIMI

PRECISION MILLING CHUCK SET IN BOX

DEĞERLİ®

www.degerlimakina.com



Sipariş Kodu Order Number	Ürün Adı Product Name	Adet Piece	Ölçüler Contents
598420	SK 40 RULMANLI PENS TAKIMI PRECISION MILLING CHUCK SET IN BOX	7	6-8-10-12-16 - 904550 - 518420
598432	SK 40 RULMANLI PENS TAKIMI PRECISION MILLING CHUCK SET IN BOX	9	6-8-10-12-16-20-25-906875 - 518432
599520	SK 50 RULMANLI PENS TAKIMI PRECISION MILLING CHUCK SET IN BOX	7	6-8-10-12-16 - 904550 - 519520
599532	SK 50 RULMANLI PENS TAKIMI PRECISION MILLING CHUCK SET IN BOX	9	6-8-10-12-16-20-25-906875 - 519532

DIN 228-1 FORM - A/B

MK TUTUCULAR
MK TOOLHOLDERS



MK4 BVK
40384 PPK
11 03 16 23





DEĞERLİ
www.degerlimakina.com

DIN 228 - 1 FORM A

MK ŞAFT ÖLÇÜLERİ

MK TOOLHOLDERS NORM

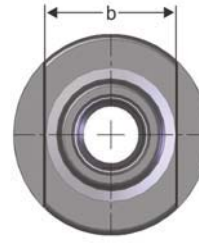
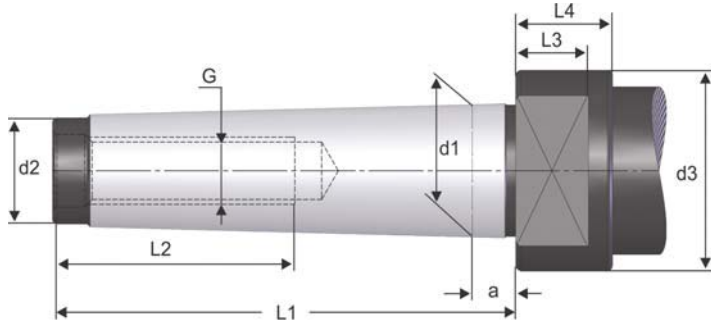

Ürün Adı Product Name	d1	a	G	d2	d3	b	L1	L2	L3	L4
MK 2	17,780	5	M10	14	-	-	69	24	-	-
MK 3	23,825	5	M12	19	36	24	86	28	12	18
MK 4	31,267	6,5	M16	25	43	32	109	32	15	23
MK 5	44,399	6,5	M20	35,7	60	45	136	40	18	28

DIN 228 - 1 FORM A

DIN 6391 / 6388 PENS BAŞLIĞI

DIN 6391 / 6388 COLLET CHUCK

DEĞERLİ®

www.degerlimakina.com

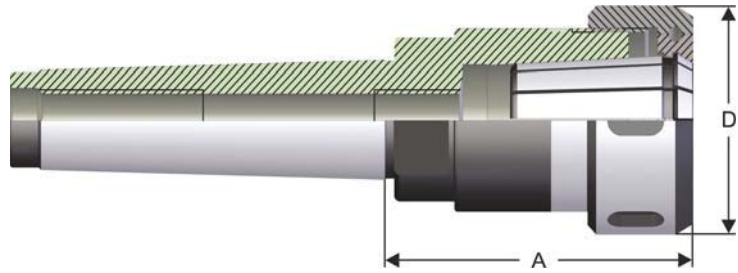

Sipariş Kodu Order Number	Ürün Adı Product Name	Kapasite Capacity (d)	D	A
612415	MK 2 - 415 PENS BAŞLIĞI / COLLET CHUCK	2-16 mm	43	69
613415	MK 3 - 415 PENS BAŞLIĞI / COLLET CHUCK	2-16 mm	43	84
613462	MK 3 - 462 PENS BAŞLIĞI / COLLET CHUCK	2-25 mm	60	89
614462	MK 4 - 462 PENS BAŞLIĞI / COLLET CHUCK	2-25 mm	60	89
614467	MK 4 - 467 PENS BAŞLIĞI / COLLET CHUCK	3-32 mm	72	109
615462	MK 5 - 462 PENS BAŞLIĞI / COLLET CHUCK	2-25 mm	60	89
615467	MK 5 - 467 PENS BAŞLIĞI / COLLET CHUCK	3-32 mm	72	114
615468	MK 5 - 468 PENS BAŞLIĞI / COLLET CHUCK	3-40 mm	85	119



DEĞERLİ
www.degerlimakina.com

DIN 228 - 1 FORM A

DIN 6358 KOMBİNE TARAMA TUTUCUSU

DIN 6358 COMBI SHELL MILL HOLDER

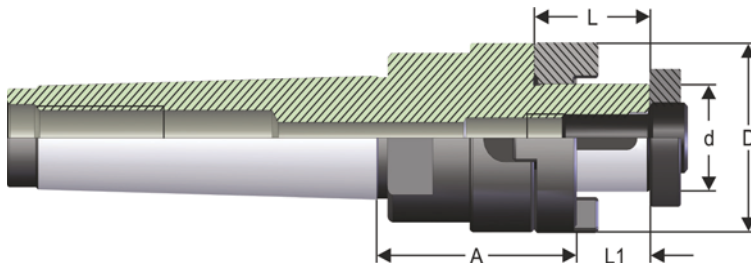

Sipariş Kodu Order Number	Ürün Adı Product Name	d h6	D	A	L	L1
620416	MK 4 - K.T.B. 16 / COMBI SHELL MILL HOLDER	16	32	60	27	17
620422	MK 4 - K.T.B. 22 / COMBI SHELL MILL HOLDER	22	40	60	31	19
620427	MK 4 - K.T.B. 27 / COMBI SHELL MILL HOLDER	27	48	60	33	21
620432	MK 4 - K.T.B. 32 / COMBI SHELL MILL HOLDER	32	58	60	38	24
620440	MK 4 - K.T.B. 40 / COMBI SHELL MILL HOLDER	40	70	60	41	27
620516	MK 5 - K.T.B. 16 / COMBI SHELL MILL HOLDER	16	32	65	27	17
620522	MK 5 - K.T.B. 22 / COMBI SHELL MILL HOLDER	22	40	65	31	19
620527	MK 5 - K.T.B. 27 / COMBI SHELL MILL HOLDER	27	48	65	33	21
620532	MK 5 - K.T.B. 32 / COMBI SHELL MILL HOLDER	32	58	65	38	24
620540	MK 5 - K.T.B. 40 / COMBI SHELL MILL HOLDER	40	70	65	41	27

DIN 228 - 1 FORM A

DIN 6388-B PENS TAKIMLARI

DIN 6388-B COLLET SET IN BOX

DEĞERLİ®

www.degerlimakina.com



Sipariş Kodu Order Number	Ürün Adı Product Name	Adet Piece	Ölçüler Contents
692415	MK 2 - 415 PENS TAKIMI 415 COLLET SET IN BOX	16	3-4-5-6-7-8-9-10-11-12-13-14-15-16 - 904042 - 612415
693415	MK 3 - 415 PENS TAKIMI 415 COLLET SET IN BOX	16	3-4-5-6-7-8-9-10-11-12-13-14-15-16 - 904042 - 613415
693462	MK 3 - 462 PENS TAKIMI 462 COLLET SET IN BOX	18	4-5-6-7-8-9-10-11-12-14-16-18-20-22-24-25 - 905862 - 613462
694462	MK 4 - 462 PENS TAKIMI 462 COLLET SET IN BOX	18	4-5-6-7-8-9-10-11-12-14-16-18-20-22-24-25 - 905862 - 614462
694467	MK 4 - 467 PENS TAKIMI 467 COLLET SET IN BOX	18	5-6-7-8-10-12-14-16-18-20-22-24-25-28-30-32 - 906875 - 614467
695462	MK 5 - 462 PENS TAKIMI 462 COLLET SET IN BOX	18	4-5-6-7-8-9-10-11-12-14-16-18-20-22-24-25 - 905862 - 615462
695467	MK 5 - 467 PENS TAKIMI 467 COLLET SET IN BOX	18	5-6-7-8-10-12-14-16-18-20-22-24-25-28-30-32 - 906875 - 615467
695468	MK 5 - 468 PENS TAKIMI 468 COLLET SET IN BOX	22	6-7-8-9-10-12-14-16-18-20-22-24-25-28-30-32-34-36-38-40 - 908590 - 615468

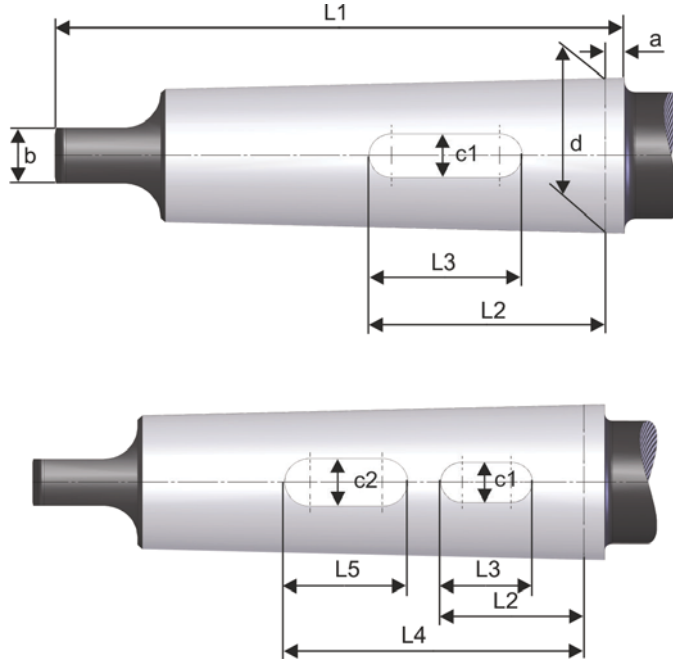

Ürün Adı Product Name	d	a	b	L1	L2	L3	L4	L5	c1	c2
MK 3	23,825	5	7,9	99	55,5	32	-	-	8,3	-
MK 4	31,267	6,5	11,9	124	59,5	37	-	-	8,3	-
MK 5	44,399	6,5	15,9	156	64	42	-	-	12,4	-
MK 6	63,348	8	19	218	56	35	122	47	16,4	19,5

DIN 228 - 1 DIN 1806 FORM B

DIN 6391 / 6388 PENS BAŞLIĞI

DIN 6391 / 6388 COLLET CHUCK

DEĞERLİ®

www.degerlimakina.com

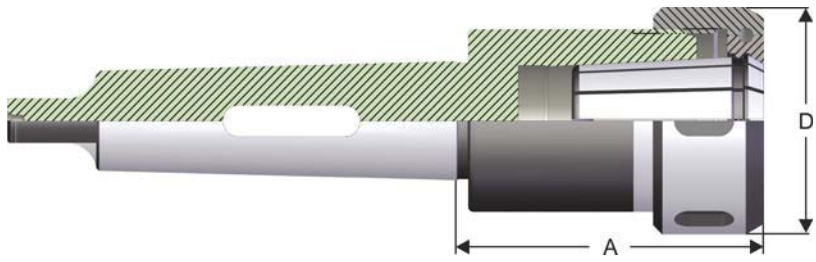

Sipariş Kodu Order Number	Ürün Adı Product Name	Kapasite Capacity (d)	D	A
713462	MK 3 - 462 BORVEK PENS BAŞLIĞI / COLLET CHUCK	2-25 mm	60	75
714462	MK 4 - 462 BORVEK PENS BAŞLIĞI / COLLET CHUCK	2-25 mm	60	84
714467	MK 4 - 467 BORVEK PENS BAŞLIĞI / COLLET CHUCK	3-32 mm	72	94
715462	MK 5 - 462 BORVEK PENS BAŞLIĞI / COLLET CHUCK	2-25 mm	60	84
715467	MK 5 - 467 BORVEK PENS BAŞLIĞI / COLLET CHUCK	3-32 mm	72	90
715468	MK 5 - 468 BORVEK PENS BAŞLIĞI / COLLET CHUCK	3-40 mm	85	100
716467	MK 6 - 467 BORVEK PENS BAŞLIĞI / COLLET CHUCK	3-32 mm	72	90
716468	MK 6 - 468 BORVEK PENS BAŞLIĞI / COLLET CHUCK	3-40 mm	85	94



DEĞERLİ
www.degerlimakina.com

DIN 228 - 1 DIN 1806 FORM B

DIN 6358 KOMBİNE TARAMA TUTUCUSU

DIN 6358 COMBI SHELL MILL HOLDER

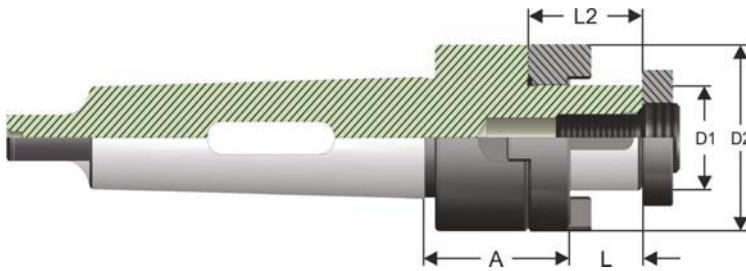

Sipariş Kodu Order Number	Ürün Adı Product Name	D1 h6	D2	A	L	L2
720416	MK 4 - BORVEK K.T.B. 16 / COMBI SHELL MILL HOLDER	16	32	45	17	27
720422	MK 4 - BORVEK K.T.B. 22 / COMBI SHELL MILL HOLDER	22	40	45	19	31
720427	MK 4 - BORVEK K.T.B. 27 / COMBI SHELL MILL HOLDER	27	48	45	21	33
720432	MK 4 - BORVEK K.T.B. 32 / COMBI SHELL MILL HOLDER	32	58	45	24	38
720440	MK 4 - BORVEK K.T.B. 40 / COMBI SHELL MILL HOLDER	40	70	45	27	41
720516	MK 5 - BORVEK K.T.B. 16 / COMBI SHELL MILL HOLDER	16	32	45	17	27
720522	MK 5 - BORVEK K.T.B. 22 / COMBI SHELL MILL HOLDER	22	40	45	19	31
720527	MK 5 - BORVEK K.T.B. 27 / COMBI SHELL MILL HOLDER	27	48	45	21	33
720532	MK 5 - BORVEK K.T.B. 32 / COMBI SHELL MILL HOLDER	32	58	45	24	38
720540	MK 5 - BORVEK K.T.B. 40 / COMBI SHELL MILL HOLDER	40	70	45	27	41
720622	MK 6 - BORVEK K.T.B. 22 / COMBI SHELL MILL HOLDER	22	40	50	19	31
720627	MK 6 - BORVEK K.T.B. 27 / COMBI SHELL MILL HOLDER	27	48	50	21	33
720632	MK 6 - BORVEK K.T.B. 32 / COMBI SHELL MILL HOLDER	32	58	50	24	38
720640	MK 6 - BORVEK K.T.B. 40 / COMBI SHELL MILL HOLDER	40	70	50	27	41

DIN 228 - 1 DIN 1806 FORM B

DIN 6388-B PENS TAKIMLARI

DIN 6388-B COLLET SET IN BOX

DEĞERLİ®

www.degerlimakina.com



Sipariş Kodu Order Number	Ürün Adı Product Name	Adet Piece	Ölçüler Contents
793462	MK 3 - BORVEK 462 PENS TAKIMI 462 COLLET SET IN BOX	18	4-5-6-7-8-9-10-11-12-14-16-18-20-22-24-25 - 905862 - 713462
794462	MK 4 - BORVEK 462 PENS TAKIMI 462 COLLET SET IN BOX	18	4-5-6-7-8-9-10-11-12-14-16-18-20-22-24-25 - 905862 - 714462
794467	MK 4 - BORVEK 467 PENS TAKIMI 467 COLLET SET IN BOX	18	5-6-7-8-10-12-14-16-18-20-22-24-25-28-30-32 - 906875 - 714467
795462	MK 5 - BORVEK 462 PENS TAKIMI 462 COLLET SET IN BOX	18	4-5-6-7-8-9-10-11-12-14-16-18-20-22-24-25 - 905862 - 715462
795467	MK 5 - BORVEK 467 PENS TAKIMI 467 COLLET SET IN BOX	18	5-6-7-8-10-12-14-16-18-20-22-24-25-28-30-32 - 906875 - 715467
795468	MK 5 - BORVEK 468 PENS TAKIMI 468 COLLET SET IN BOX	22	6-7-8-9-10-12-14-16-18-20-22-24-25-28-30-32-34-36-38-40 - 908590 - 715468
796467	MK 6 - BORVEK 467 PENS TAKIMI 467 COLLET SET IN BOX	18	5-6-7-8-10-12-14-16-18-20-22-24-25-28-30-32 - 906875 - 716467
796468	MK 6 - BORVEK 468 PENS TAKIMI 468 COLLET SET IN BOX	22	6-7-8-9-10-12-14-16-18-20-22-24-25-28-30-32-34-36-38-40 - 908590 - 716468

DIĐER ÜRÜNLER
OTHER PRODUCTS

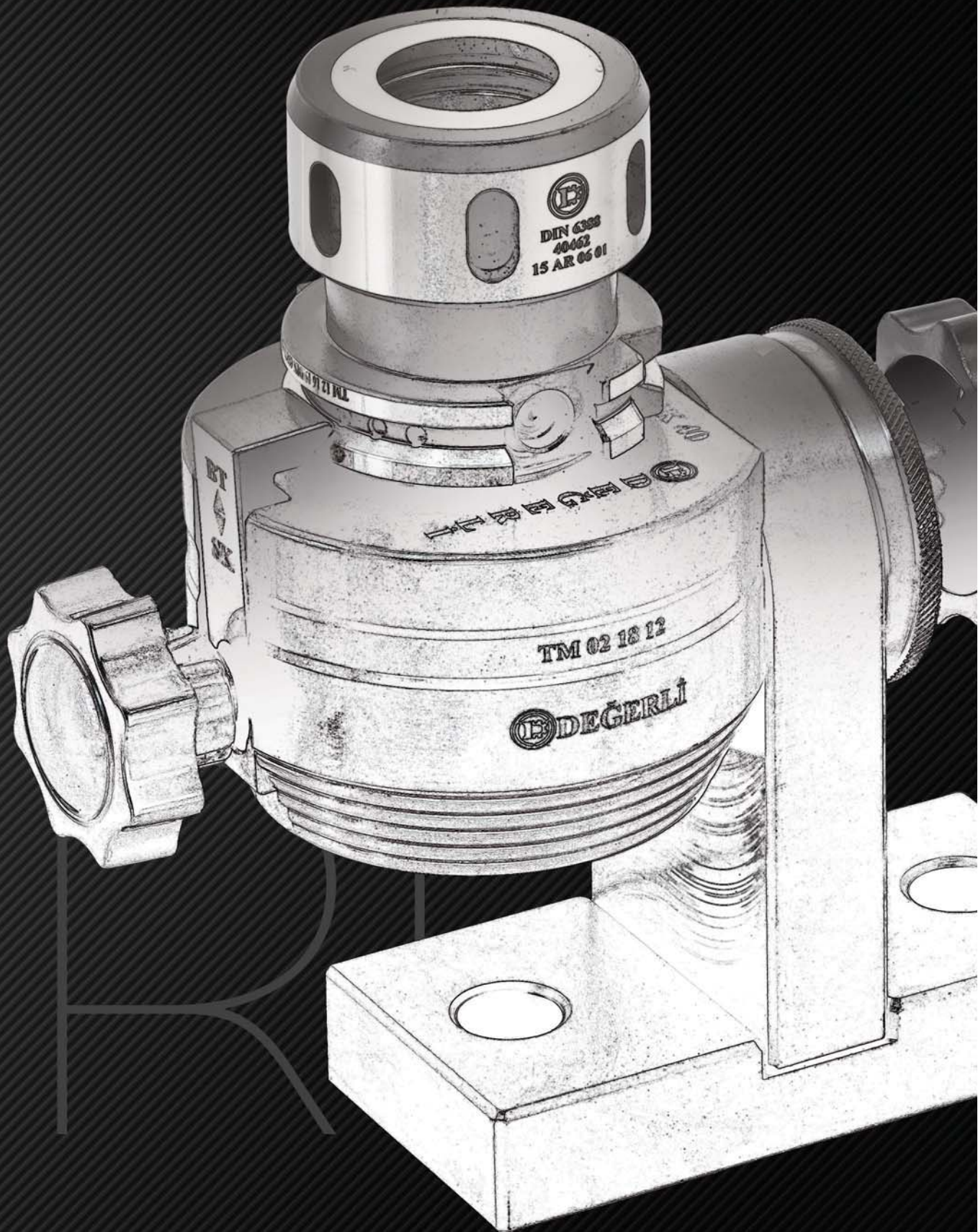

DIN 6358
40462
15 AR 06 01

DEĞERLİ

TM 02 18 12

DEĞERLİ



DEĞERLİ
www.degerlimakina.com

CNC MARANGOZ TEZGALARI İÇİN ÖZEL TAKIMLAR
CNC SPECIAL TEAMS FOR CARPENTRY TOOLS



Sipariş Kodu Order Number	Ürün Adı Product Name
510470.MRZ	SK 30 / ER 32 - 470 / CNC CARPENTER COLLET CHUCK (A - 50)
510470.MRZS	SK 30 / ER 32 - 470 SOMUNLU / CNC CARPENTER COLLET CHUCK
55030.MRZ	SK 30 MARANGOZ MONTAJ APARATI / WOOD CNC
23065	SK 30 CNC MRZ PULLSTUD 6,5 RADIUS



Sipariş Kodu
Order Number

Ürün Adı
Product Name

HSK.01

HSK - F 63 / 462 (A - 78) / COLLET CHUCK

HSK.02

HSK - F 63 / ER-32 470 (A - 70) / COLLET CHUCK

HSK.03

HSK - F 63 / ER-40 472 (A - 78) / COLLET CHUCK

55063

HSK - A 63 ÇELİK MONTAJ APARATI / METAL CNC

55063.MRZ

HSK - F 63 ÇELİK MONTAJ APARATI / WOOD CNC



DEĞERLİ
www.degerlimakina.com

DIN 1810 - A

AY ANAHTARI

WRENCH



Sipariş Kodu Order Number	Ürün Adı Product Name	d	D
904042	415 AY ANAHTARI / WRENCH	40	42
904550	440 / 6-20 RULMANLI AY ANAHTARI / WRENCH	45	50
905862	462 AY ANAHTARI / WRENCH	58	62
906875	467 / 6-32 RULMANLI AY ANAHTARI / WRENCH	68	75
908590	468 AY ANAHTARI / WRENCH	85	90

DIN 6499

ER TİPİ ANAHTAR

ER TYPE WRENCH

DEĞERLİ®

www.degerlimakina.com



Sipariş Kodu Order Number	Ürün Adı Product Name	Kapasite Capacity (d)
9022426	426 (ER 16) KAPAK ANAHTARI / WRENCH	22
9028428	428 (ER 20) KAPAK ANAHTARI / WRENCH	28
9032426	426 (ER 16) KAPAK ANAHTARI / WRENCH	32
9035428	428 (ER 20) KAPAK ANAHTARI / WRENCH	35
9042430	430 (ER 25) KAPAK ANAHTARI / WRENCH	42
9050470	470 (ER 32) KAPAK ANAHTARI / WRENCH	50
9063472	472 (ER 40) KAPAK ANAHTARI / WRENCH	63



DEĞERLİ
www.degerlimakina.com

DIN 55021

HİDROLİK PENS AYNASI

QUICK ACTION COLLET CHUCK

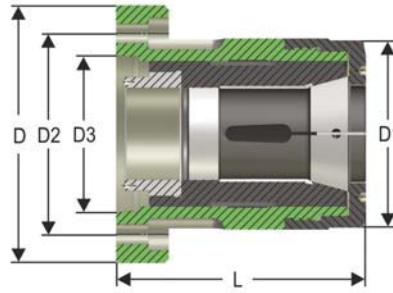

Sipariş Kodu Order Number	Ürün Adı Product Name	Max Devir Max Rpm	D	L	D1	D3	D2	Pens Kodu Collet Nr.
93040	H.P.A 40 / 5	5000	135	132	100	6"	104,8	173 D
93140	H.P.A 40 / 6	5000	165	134	118	8"	133,4	173 D
93060	H.P.A 60 / 6	4500	165	151	122	8"	133,4	185 D
93160	H.P.A 60 / 8	4000	208	154	138	10"	171,4	185 D



HPA MAŞONLAR / HPA INNER BUSH WITH BUSHES NUT

Sipariş Kodu Order Number	Ürün Adı Product Name	M
93040-1	H.P.A 40 / 5 - MAŞON - HPA INNER BUSH	M66x1,5
93140-1	H.P.A 40 / 6 - MAŞON - HPA INNER BUSH	M80x1,5
93060-1	H.P.A 60 / 6 - MAŞON - HPA INNER BUSH	M80x1,5
93160-1	H.P.A 60 / 8 - MAŞON - HPA INNER BUSH	M98x1,5

HPA KAPAK ANAHTARI / WRENCH OF HPA CLAMPING NUT

Sipariş Kodu Order Number	Ürün Adı Product Name	D
93040 / 93140 -2	H.P.A 40 - 5 / 40 - 6 KAPAK ANAHTARI / WRENCH	66
93060 / 93160 -2	H.P.A 60 - 6 / 60 - 8 KAPAK ANAHTARI / WRENCH	87

HPA MAŞON ANAHTARI / HPA ASSEMBLING WRECH

Sipariş Kodu Order Number	Ürün Adı Product Name	D
93140-3	H.P.A 40 - 6 MAŞON ANAHTARI / WRENCH	48
93060-3	H.P.A 60 - 6 MAŞON ANAHTARI / WRENCH	64

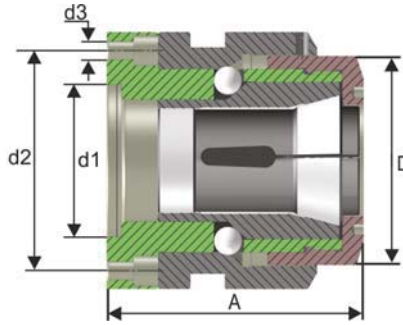

Sipariş Kodu Order Number	Ürün Adı Product Name	Max Devir Max Rpm	D	d1	LkØ	d2	A	d3
92040	MBPA / 40-S / 173 D	2000	96	70	101	6 x 8,5	130	8,5

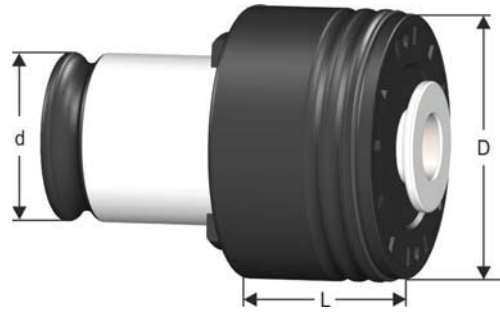

Sipariş Kodu Order Number	Ürün Adı Product Name	D	d	L	Kare Square
8 19 28.M2	ŞAFT Ø 2,8 M2 ADAPTÖR / TAPPING COLLETS WITH CLUTCH	32	19	25	2,1
8 19 28.M2,5	ŞAFT Ø 2,8 M2,5 ADAPTÖR / TAPPING COLLETS WITH CLUTCH	32	19	25	2,1
8 19 35.M3	ŞAFT Ø 3,5 M3 ADAPTÖR / TAPPING COLLETS WITH CLUTCH	32	19	25	2,7
8 19 40.M3,5	ŞAFT Ø 4 M3,5 ADAPTÖR / TAPPING COLLETS WITH CLUTCH	32	19	25	3,0
8 19 45.M4	ŞAFT Ø 4,5 M4 ADAPTÖR / TAPPING COLLETS WITH CLUTCH	32	19	25	3,4
8 19 60.M5	ŞAFT Ø 6 M5 ADAPTÖR / TAPPING COLLETS WITH CLUTCH	32	19	25	4,9
8 19 60.M6	ŞAFT Ø 6 M6 ADAPTÖR / TAPPING COLLETS WITH CLUTCH	32	19	25	4,9
8 19 80.M8	ŞAFT Ø 8 M8 ADAPTÖR / TAPPING COLLETS WITH CLUTCH	32	19	25	6,2
8 19 70.M10	ŞAFT Ø 7 M10 ADAPTÖR / TAPPING COLLETS WITH CLUTCH	32	19	25	5,5
8 19 10.M10	ŞAFT Ø 10 M10 ADAPTÖR / TAPPING COLLETS WITH CLUTCH	32	19	25	8,0
8 19 90.M12	ŞAFT Ø 9 M12 ADAPTÖR / TAPPING COLLETS WITH CLUTCH	32	19	25	7,0
8 19 11.M14	ŞAFT Ø 11 M14 ADAPTÖR / TAPPING COLLETS WITH CLUTCH	32	19	25	9,0

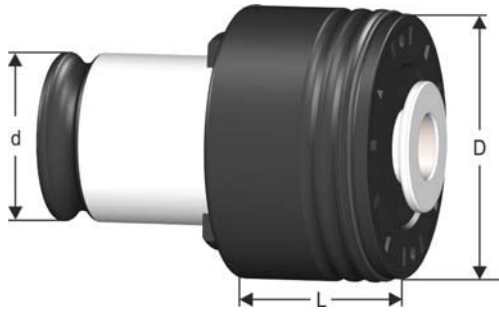

Sipariş Kodu Order Number	Ürün Adı Product Name	D	d	L	Kare Square
8 31 60.M5	ŞAFT Ø 6 M5 ADAPTÖR / TAPPING COLLETS WITH CLUTCH	50	31	31	4,9
8 31 60.M6	ŞAFT Ø 6 M6 ADAPTÖR / TAPPING COLLETS WITH CLUTCH	50	31	31	4,9
8 31 80.M8	ŞAFT Ø 8 M8 ADAPTÖR / TAPPING COLLETS WITH CLUTCH	50	31	31	6,2
8 31 70.M10	ŞAFT Ø 7 M10 ADAPTÖR / TAPPING COLLETS WITH CLUTCH	50	31	31	5,5
8 31 10.M10	ŞAFT Ø 10 M10 ADAPTÖR / TAPPING COLLETS WITH CLUTCH	50	31	31	8,0
8 31 90.M12	ŞAFT Ø 9 M12 ADAPTÖR / TAPPING COLLETS WITH CLUTCH	50	31	31	7,0
8 31 11.M14	ŞAFT Ø 11 M14 ADAPTÖR / TAPPING COLLETS WITH CLUTCH	50	31	31	9,0
8 31 12.M16	ŞAFT Ø 12 M16 ADAPTÖR / TAPPING COLLETS WITH CLUTCH	50	31	31	9,0
8 31 14.M18	ŞAFT Ø 14 M18 ADAPTÖR / TAPPING COLLETS WITH CLUTCH	50	31	31	11,0
8 31 16.M20	ŞAFT Ø 16 M20 ADAPTÖR / TAPPING COLLETS WITH CLUTCH	50	31	31	12,0
8 31 18.M22	ŞAFT Ø 18 M22 ADAPTÖR / TAPPING COLLETS WITH CLUTCH	50	31	31	14,5
8 31 18.M24	ŞAFT Ø 18 M24 ADAPTÖR / TAPPING COLLETS WITH CLUTCH	50	31	31	14,5

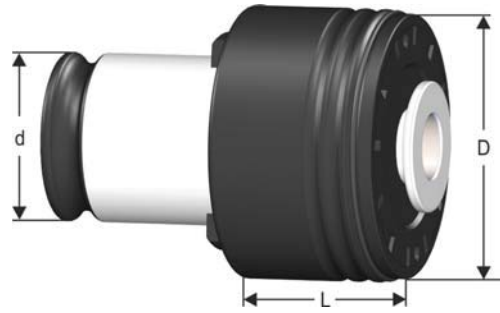

Sipariş Kodu Order Number	Ürün Adı Product Name	D	d	L	Kare Square
8 48 11.M14	ŞAFT Ø 11 M14 ADAPTÖR / TAPPING COLLETS WITH CLUTCH	72	48	41	9,0
8 48 12.M16	ŞAFT Ø 12 M16 ADAPTÖR / TAPPING COLLETS WITH CLUTCH	72	48	41	9,0
8 48 14.M18	ŞAFT Ø 14 M18 ADAPTÖR / TAPPING COLLETS WITH CLUTCH	72	48	41	11,0
8 48 16.M20	ŞAFT Ø 16 M20 ADAPTÖR / TAPPING COLLETS WITH CLUTCH	72	48	41	12,0
8 48 18.M22	ŞAFT Ø 18 M22 ADAPTÖR / TAPPING COLLETS WITH CLUTCH	72	48	41	14,5
8 48 18.M24	ŞAFT Ø 18 M24 ADAPTÖR / TAPPING COLLETS WITH CLUTCH	72	48	41	14,5
8 48 20.M27	ŞAFT Ø 20 M27 ADAPTÖR / TAPPING COLLETS WITH CLUTCH	72	48	41	16,0
8 48 22.M30	ŞAFT Ø 22 M30 ADAPTÖR / TAPPING COLLETS WITH CLUTCH	72	48	41	18,0
8 48 25.M33	ŞAFT Ø 25 M33 ADAPTÖR / TAPPING COLLETS WITH CLUTCH	72	48	41	20,0
8 48 28.M36	ŞAFT Ø 28 M36 ADAPTÖR / TAPPING COLLETS WITH CLUTCH	72	48	41	22,0

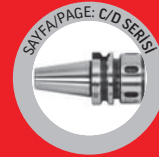
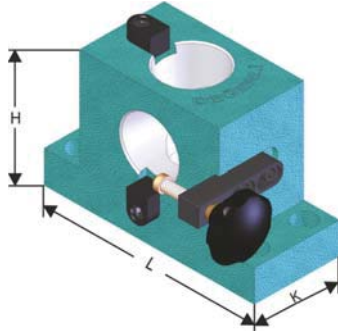

Sipariş Kodu
Order Number

65040

Ürün Adı
Product Name

ISO 30 / BT 30 / SK 30 MONTAJ APARATI - TIGHTENING FIXTURES

H

105

L

160

K

62

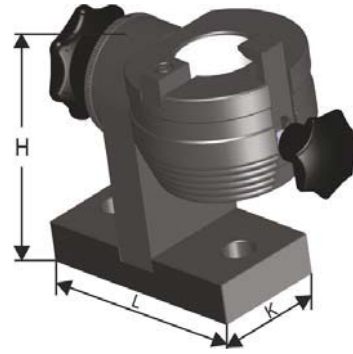
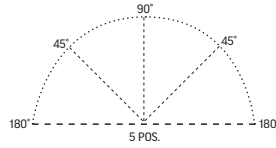

Sipariş Kodu
Order Number

Ürün Adı
Product Name

H L K

55030	ISO 30 / BT 30 / SK 30 ÇELİK MONTAJ APARATI / UNIVERSAL ASSEMBLY BLOCK STEEL	121	100	48
55040	ISO 40 / BT 40 / SK 40 ÇELİK MONTAJ APARATI / UNIVERSAL ASSEMBLY BLOCK STEEL	136	130	64
55050	ISO 50 / BT 50 / SK 50 ÇELİK MONTAJ APARATI / UNIVERSAL ASSEMBLY BLOCK STEEL	170	170	72



DEĞERLİ
www.degerlimakina.com

DIN 6388 D

E SERİSİ PENS KAPAĞI

CLAMPING NUTS BALL-BEARING VERSION

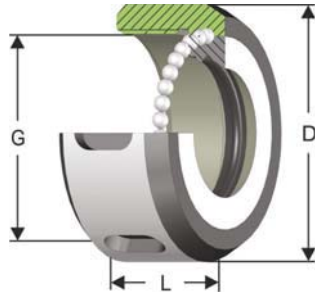

Sipariş Kodu Order Number	Ürün Adı Product Name	Kapasite Capacity (d)	D	G	L
40407	407 KAPAK / CLAMPING NUTS	2-12 mm	35	M27 x 1,5	20
40415	415 KAPAK / CLAMPING NUTS	2-16 mm	43	M33 x 1,5	24
40440	440 KAPAK / CLAMPING NUTS	2-20 mm	50	M42 x 2	28
40462	462 KAPAK / CLAMPING NUTS	2-25 mm	60	M48 x 2	30
40467	467 KAPAK / CLAMPING NUTS	3-32 mm	72	M60 x 2,5	33,5
40468	468 KAPAK / CLAMPING NUTS	4-40 mm	85	M68 x 2,5	37



TYPE 1

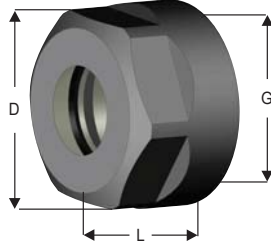

TYPE 2

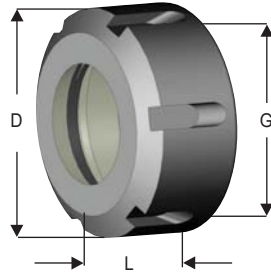

TYPE 3

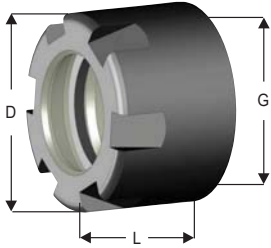

Sipariş Kodu Order Number	Ürün Adı Product Name	Kapasite Capacity (d)	D	G	L	SW	TYPE
40426	ER 16 - 426 KAPAK / CLAMPING NUT	2-10 mm	28	M22 x 1,5	17,5	25	1
41426	ER 16 - 426 MİNİ KAPAK / CLAMPING NUT	2-10 mm	22	M19 x 1	18	-	3
42426	ER 16 - 426 KAPAK / CLAMPING NUT	2-10 mm	32	M22 x 1,5	17,5	-	2
40428	ER 20 - 428 KAPAK / CLAMPING NUT	2-13 mm	34	M25 x 1,5	19	30	1
41428	ER 20 - 428 MİNİ KAPAK / CLAMPING NUT	2-13 mm	28	M24 x 1	19	-	3
42428	ER 20 - 428 KAPAK / CLAMPING NUT	2-13 mm	35	M25 x 1,5	19	-	2
40430	ER 25 - 430 KAPAK / CLAMPING NUT	2-16 mm	42	M32 x 1,5	20	-	2
40470	ER 32 - 470 KAPAK / CLAMPING NUT	2-20 mm	50	M40 x 1,5	22,5	-	2
40472	ER 40 - 472 KAPAK / CLAMPING NUT	2-26 mm	63	M50 x 1,5	25,5	-	2

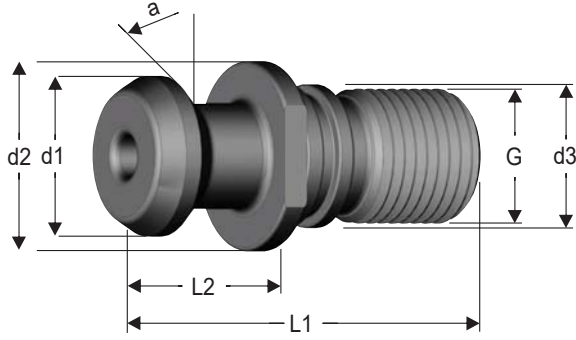

Sipariş Kodu Order Number	Ürün Adı Product Name	d1	d2	d3	L1	L2	G	a
21445	CAT 40 MAZAK PULLSTUD	18,80	22	17	41,25	16,10	M16	45°
21445.1	BT 40 MAZAK PULLSTUD	18,80	22,5	17	44,10	19,10	M16	45°
21545	ISO 7388 / B 50 PULLSTUD	28,95	37	25	65,40	25,40	M24	45°
22445	ISO 7388 / B 40 PULLSTUD	18,95	22,5	17	44,50	16,40	M16	45°
22545	CAT 50 MAZAK PULLSTUD	29,10	37	25	65,50	25,55	M24	45°
24445	HAAS PULLSTUD	15	23	17	57	32	M16	45°
24445.1	HAAS WITH THROUGH HOLE AND O-RING Ø 3,5 mm	15	23	17	57	32	M16	45°

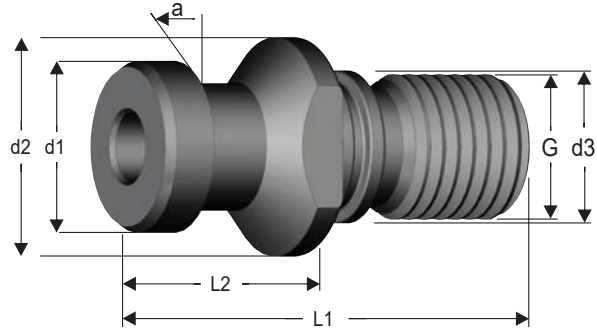

Sipariş Kodu Order Number	Ürün Adı Product Name	d1	d2	d3	L1	L2	G	a
23015	DIN 69872 SK 30 PULLSTUD	13	17	13	44	24	M12	15°
24015	DIN 69872 SK 40 PULLSTUD	19	23	17	54	26	M16	15°
25015	DIN 69872 SK 50 PULLSTUD	28	36	25	74	34	M24	15°
24115	DIN 69872 SK 40 İ.S.V. PULLSTUD	19	23	17	54	26	M16	15°
25115	DIN 69872 SK 50 İ.S.V.PULLSTUD	28	36	25	74	34	M24	15°
24215	MAKİNO Ø 5 mm WITH THROUGH HOLE	19	23	17	54	29	M16	15°
24315	OKUMA Ø 7 mm WITH THROUGH HOLE AND O-RING	19	23	17	54	29	M16	15°
24415	OKUMA & MAKİNO Ø 7 mm WITH THROUGH HOLE	19	23	17	54	29	M16	15°



DEĞERLİ
www.degerlimakina.com

JIS B 6339 (MAS 403 BT)

ÇEKTİRME CİVATALARI

PULL STUDS

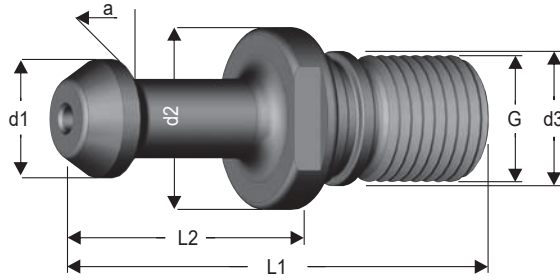

Sipariş Kodu Order Number	Ürün Adı Product Name	d1	d2	d3	L1	L2	G	a
23045	MAS 403 BT - BBT 30 PULLSTUD	11	16,5	12,5	43	23	M12	45°
24045	MAS 403 BT - BBT 40 PULLSTUD	15	23	17	60	35	M16	45°
25045	MAS 403 BT - BBT 50 PULLSTUD	23	38	25	85	45	M24	45°
23060	MAS 403 BT - BBT 30 PULLSTUD	11	16,5	12,5	43	23	M12	60°
24060	MAS 403 BT - BBT 40 PULLSTUD	15	23	17	60	35	M16	60°
25060	MAS 403 BT - BBT 50 PULLSTUD	23	38	25	85	45	M24	60°
23090	MAS 403 BT - BBT 30 PULLSTUD	11	16,5	12,5	43	23	M12	90°
24090	MAS 403 BT - BBT 40 PULLSTUD	15	23	17	60	35	M16	90°
25090	MAS 403 BT - BBT 50 PULLSTUD	23	38	25	85	45	M24	90°

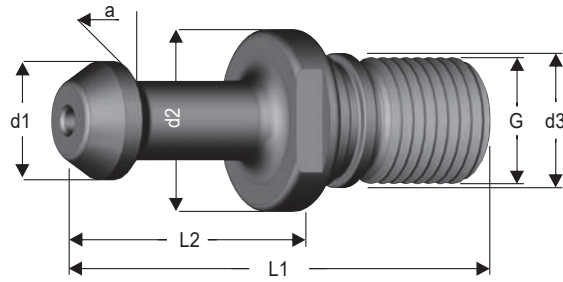

Sipariş Kodu Order Number	Ürün Adı Product Name	d1	d2	d3	L1	L2	G	a
23145	MAS 403 BT - BBT 30 İ.S.V. PULLSTUD	11	16,5	12,5	43	23	M12	45°
24145	MAS 403 BT - BBT 40 İ.S.V. PULLSTUD	15	23	17	60	35	M16	45°
25145	MAS 403 BT - BBT 50 İ.S.V. PULLSTUD	23	38	25	85	45	M24	45°
24160	MAS 403 BT - BBT 40 İ.S.V. PULLSTUD	15	23	17	60	35	M16	60°
25160	MAS 403 BT - BBT 50 İ.S.V. PULLSTUD	23	38	25	85	45	M24	60°
24190	MAS 403 BT - BBT 40 İ.S.V. PULLSTUD	15	23	17	60	35	M16	90°
25190	MAS 403 BT - BBT 50 İ.S.V. PULLSTUD	23	38	25	85	45	M24	90°



DEĞERLİ
www.degerlimakina.com

DIN 2080

ÇEKTİRME CİVATALARI

PULL STUDS

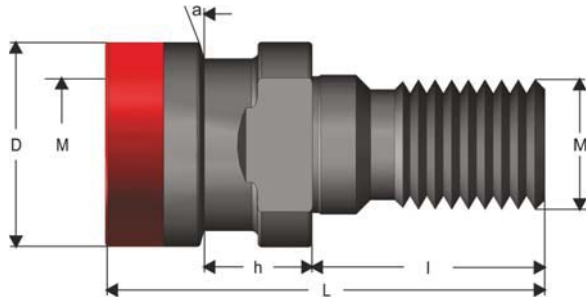

Sipariş Kodu
Order Number

Ürün Adı
Product Name

D

M

L

I

h

a

26016

40 İÇTEN ÇEKTİRMELİ PULLSTUD

25

M16

53

28

13,7 15°

26024

50 İÇTEN ÇEKTİRMELİ PULLSTUD

39,2

M24

65

40

13 15°

DIN 1835 B

VELDON CİVATASI

CLAMPING SCREW WELDON

DEĞERLİ[®]

www.degerlimakina.com

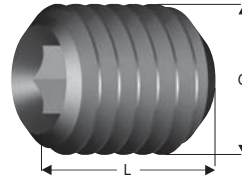

Sipariş Kodu Order Number	Ürün Adı Product Name	G	L
9006	WELDON 6	M6	10
9008	WELDON 8	M8	10
9010	WELDON 10	M10	12
9012	WELDON 12	M12	16
9016	WELDON 16	M14	16
9020	WELDON 20	M16	16
9025	WELDON 25	M18 x 2	20
9032	WELDON 32	M20 x 2	20
9040	WELDON 40	M20 x 2	20

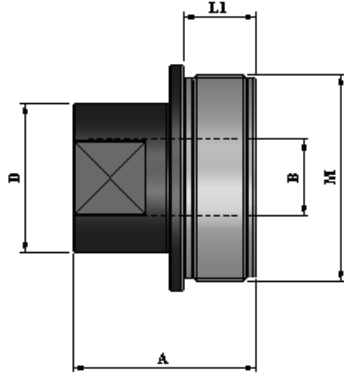

Sipariş Kodu Order Number	Ürün Adı Product Name	M	B	A	D	L1
110042.D	173 D DAYAMA / PLUG	M43x1	M16	38	31	15
110060.D	185 D DAYAMA / PLUG	M61x1	M16	38	31	15



Sipariş Kodu
Order Number

Ürün Adı
Product Name

63016

ATB 16 KAMA / COTTER

63022

ATB 22 KAMA / COTTER

63027

ATB 27 KAMA / COTTER

63032

ATB 32 KAMA / COTTER

63040

ATB 40 KAMA / COTTER

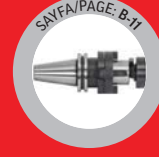
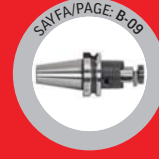
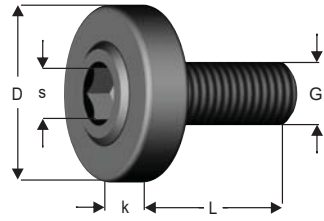

Sipariş Kodu Order Number	Ürün Adı Product Name	G	D	k	L	s
60816	16 TARAMA VİDASI / LOCK SCREW	M8	20	6	16	6
61022	22 TARAMA VİDASI / LOCK SCREW	M10	28	7	18	8
61227	27 TARAMA VİDASI / LOCK SCREW	M12	35	8	22	10
61632	32 TARAMA VİDASI / LOCK SCREW	M16	42	9	26	14
62040	40 TARAMA VİDASI / LOCK SCREW	M20	52	10	30	17

DIN 6366**TAŞIYICI TIRNAKLI PUL**
DRIVING RING**DEĞERLİ**
www.degerlimakina.com

SAYFA/PAGE: B-09



SAYFA/PAGE: B-10



SAYFA/PAGE: B-11



SAYFA/PAGE: F-09/10



SAYFA/PAGE: F-11



SAYFA/PAGE: B-05



SAYFA/PAGE: H-24



SAYFA/PAGE: H-13



SAYFA/PAGE: H-12



58-60 HRC

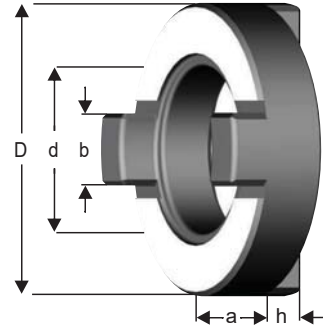

Sipariş Kodu Order Number	Ürün Adı Product Name	d	a	D	b	h
64016	K.T.B. 16 TIRNAKLI PUL / DRIVING RING	16	10	32	8	5
64022	K.T.B. 22 TIRNAKLI PUL / DRIVING RING	22	12	40	10	5,6
64027	K.T.B. 27 TIRNAKLI PUL / DRIVING RING	27	12	48	12	6,3
64032	K.T.B. 32 TIRNAKLI PUL / DRIVING RING	32	14	58	14	7
64040	K.T.B. 40 TIRNAKLI PUL / DRIVING RING	40	14	70	16	8



DEĞERLİ
www.degerlimakina.com

BT - SK FENER MİLİ KONTROL MASTARI

BT - SK TEST ARBORS

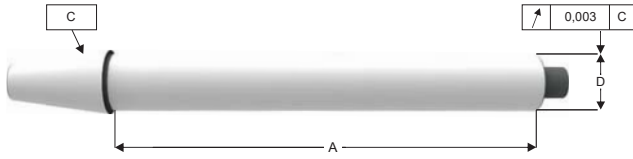

Sipariş Kodu
Order Number

Ürün Adı
Product Name

A

D

0030-1 BT - SK 30 KONTROL MASTARI / TEST ARBORS

200

32

0040-1 BT - SK 40 KONTROL MASTARI / TEST ARBORS

300

40

0050-1 BT - SK 50 KONTROL MASTARI / TEST ARBORS

300

50

BT - SK FENER MİLİ ÇEKME KUVVETİ APARATI

BT - SK POWER CHECK

DEĞERLİ®

www.degerlimakina.com



Sipariş Kodu
Order Number

Ürün Adı
Product Name

0030

BT - SK 30 KONTROL APARATI / POWER CHECK

0040

BT - SK 40 KONTROL APARATI / POWER CHECK

0050

BT - SK 50 KONTROL APARATI / POWER CHECK



DEĞERLİ
www.degerlimakina.com

HİDROLİK TEZGAH MENGENESİ
HYDRAULIC MACHINE VICES

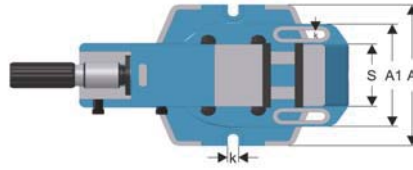
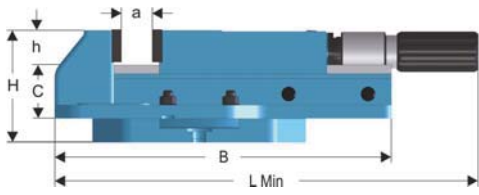
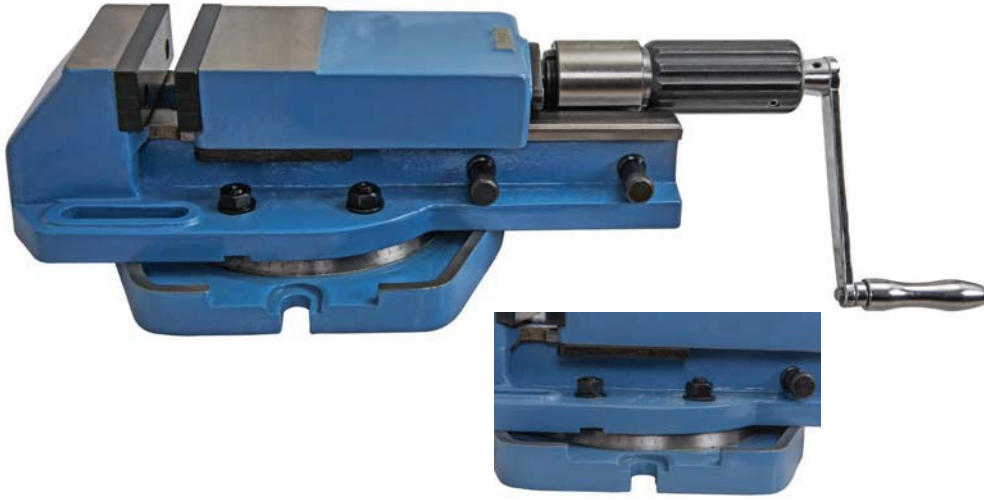

Sipariş Kodu
Order Number

Ürün Adı
Product Name

A

A1

S

k

a

10100

HİDROLİK MENGENE / HYDRAULIC VICES

270

200

122

16

0-210

h

H

C

B

L
MIN

Sıkma Gücü
Press Power

Ağırlık
Weight

45

140

68

425

500

3,5 - 4 Ton

35 Kg



SAVFA/PAGE: A-24/25/26



SAVFA/PAGE: B-13/14



SAVFA/PAGE: C-28/29/30



SAVFA/PAGE: D-16/17



SAVFA/PAGE: F-27/28/29



Sipariş Kodu Order Number	Ürün Adı Product Name	Kapasite Capacity (d)
T-2000	ER16 - ER20	BAŞLIKSIZ
T-2004	ER25 - ER32 - 415	BAŞLIKSIZ
T-2007	ER32 - ER40 - 462 - 467 - RPT 6-32	ISO-BT-SK 40
T-2008	ER32 - ER40 - 462 - 467	ISO-BT-SK 50



DEĞERLİ
www.degerlimakina.com

TAKIM ARABASI
TOOL CAR

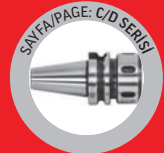
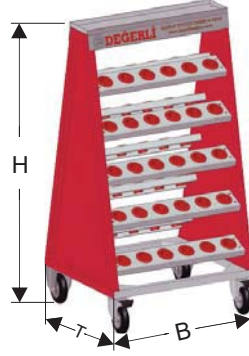

Sipariş Kodu
Order Number

Ürün Adı
Product Name

Kapasite
Capacity (d)

H

T

B

8030

ISO 30 / BT 30 / SK 30 TAKIM ARABASI - SET CAR

70

1260

600

700

8040

ISO 40 / BT 40 / SK 40 TAKIM ARABASI - SET CAR

60

1260

600

700

8050

ISO 50 / BT 50 / SK 50 TAKIM ARABASI - SET CAR

50

1260

600

700



DEĞERLİ®

www.degerlimakina.com



DEĞERLİ®



-  Horozluhan Mah. Anadolu San. Sit.
Camibaşı Sk. No: 6 Selçuklu/KONYA/TURKEY
-  +90 332 248 27 71 (pbx)
-  +90 332 251 01 40
-  degerlimakina@hotmail.com
export@degerlimakina.com
-  www.degerlimakina.com